

Tekening: **Situatie**

Woningtype: -









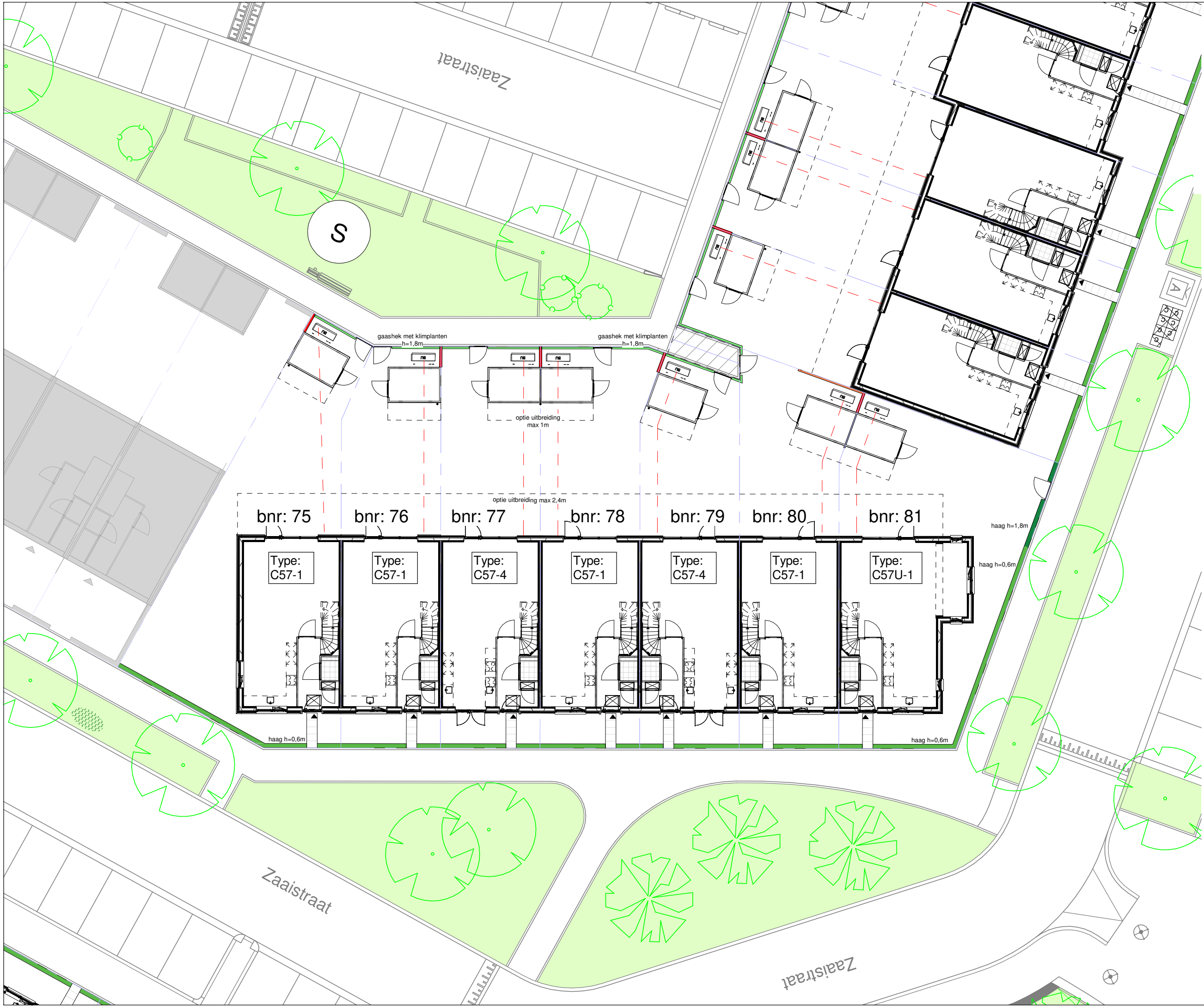









Bouwnummer: 68-95, 140

Bladnummer: VT-00-S02b

Schaal: 1:500

Datum: 04-04-2023



- ### Renvooi
-  - entree woning
 -  - erfgrans
 -  - P1 parkeervak eigen terrein
 -  - buitenunit warmtepomp
 -  - leiding buitenunit
 -  - mantelbuis t.b.v. nuts
 -  - haag H=600mm
 -  - haag H=1800mm
 -  - schutting H=1800mm
 -  - schutting H=2100mm
 -  - gaashek met klimplanten H=1800mm
 -  - plantenrol
 -  - stalen poort
 -  - mandelig terrein
 -  - speeltuin
 -  - transformatorhuis
 -  - opstelplaats vuilcontainer
 -  - ondergronds containers
 -  - hellingbaan
 -  - talud
 -  - lage houten beschoeiing

parkeerplekken en posities bomen indicatief





Tekening: **Situatie Blok 17**

Woningtype: **C60**

Bouwnummer: **75 t/m 81**

Bladnummer: **VT-17-S01**

Schaal: **1:200**

Datum: **18-04-2023**

Renvooi materialen

	dakpan donkergrijs
	dakpan grijs
	dakpan rood
	metselwerk kleur rood
	metselwerk kleur bruin
	metselwerk kleur geel
	metselwerk kleur wit
	metselwerk kleur oranje
	metselwerk kleur roodbruin
	metselwerk kleur grijs
	Gevelbetimmering vezelcement, lood
	Gevelbetimmering vezelcement, roomwit

Renvooi bouwkundig

	entree woning
	metselwerk
	isolatie
	dragende wand
	niet dragende binnenwand
	binnendeurkozijn (met bovenlicht)
	kruipluik
	opstelplaats wasmachine
	opstelplaats wasdroger
	opstelplaats koelkast
	principe opstelling keukenblok (elektra conform nultekeningen Bruynzeel)
	
	onbenoemde ruimte volgens krijtstreepmethode

Renvooi installaties

	aansluitpunt licht, wand
	centraaldoos met lichtpunt
	armatuur aan de wand
	rookmelder
	aansluitpunt niet bedraad / loos
	beldrukker
	schel
	schakelaar, 1-polig
	werkschakelaar tbv PV-panels
	driestandenschakelaar tbv wtw
	schakelaar, wissel
	schakelaar, serie
	pulsschakelaar tbv warmteterugwinunit
	wandcontactdoos 1-voudig met beschermingscontact
	wandcontactdoos 2-voudig met beschermingscontact
	thermostaatleiding, bedraad
	wandcontactdoos tbv warmteterugwinunit
	wtw mechanische ventilatie-unit incl. warmteterugwinunit
	wp warmtepomp
	inblaasventiel mechanische ventilatie
	afzuigventiel mechanische ventilatie
	wv verdeler vloerverwarming
	ruimte vzv vloerverwarming
	rad elektrische radiator
	kanalen in het zicht
	doucheput
	lijngoot douche

Disclaimer

De op deze tekeningen aangegeven maten zijn circa maten in millimeters en tussen de wanden / vloeren gemeten, waarbij geen rekening is gehouden met enige wandafwerking, plinten, aftimmering, etc. In verband met de nauwkeurige uitwerking van details, constructie, maatvoering, materialen e.d. kunnen er kleine afwijkingen ontstaan ten opzichte van de nu vermelde gegevens. Deze geringe afwijkingen geven geen aanleiding tot verrekening. Aan de op deze tekening aangegeven maten kunnen derhalve geen rechten worden ontleend. De op deze tekeningen aangegeven maatvoering is niet geschikt voor opdrachten aan derden door koper(s). De posities van aansluitingen en installatie onderdelen zijn indicatief op tekening aangegeven. De exacte aantallen en posities zullen na berekening in het werk door de installateurs worden bepaald en kunnen afwijken van deze tekening.



Tekening: Renvooi

Woningtype: -

Bouwnummer:

Bladnummer: VT-0-00c

Schaal:

Datum: 04-04-2023



Linker zijgevel

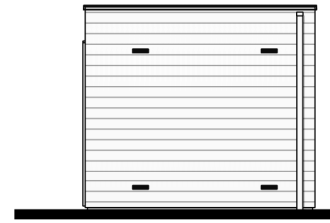

Voorgevel



Rechter zijgevel

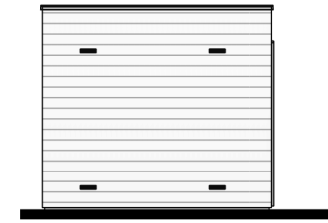

Achtergevel

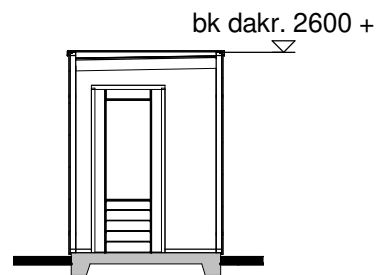

Doorsnede A

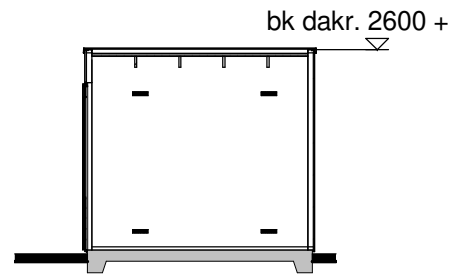

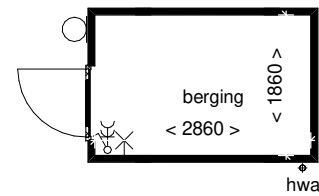

Doorsnede B







Begane grond

Renvooi

-  houten rabatdelen
-  houten wanden

Installaties

-  - enkelpolige schakelaar
-  - dubbele wandcontactdoos
-  - lichtpunt buiten
-  - lichtpunt aan wand

Disclaimer

De op deze tekening aangegeven maten zijn circa maten in millimeters en tussen de wanden / vloeren gemeten, waarbij geen rekening is gehouden met enige wandafwerking, plinten, aftimmering, etc. In verband met de nauwkeurige uitwerking van details, constructie, maatvoering, materialen e.d. kunnen er kleine afwijkingen ontstaan ten opzichte van de nu vermelde gegevens. Deze geringe afwijkingen geven geen aanleiding tot verrekening. Aan de op deze tekening aangegeven maten kunnen derhalve geen rechten worden ontleend. De op deze tekening aangegeven maatvoering is niet geschikt voor opdrachten aan derden door koper(s). De posities van aansluitingen en installatie onderdelen zijn indicatief op tekening aangegeven. De exacte aantallen en posities zullen na berekening in het werk door de installateurs worden bepaald en kunnen afwijken van deze tekening.

3D Impressie

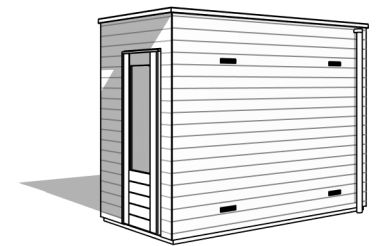

BENT
WIJK
 BENTHUIZEN

Tekening: Berging enkel

Bouwnummer: 50,61,75,76,79,82,102,103,127,138

Bladnummer: VT-00-B2-fase 2-3

Schaal: 1:100

Datum: 18-04-2023

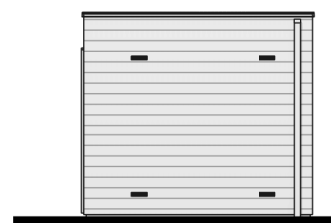

Voorgevel

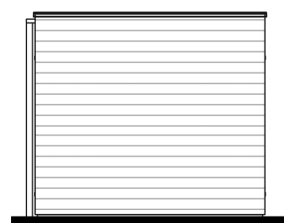

Rechter zijgevel

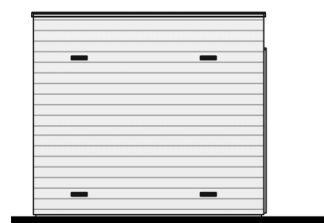

Achtergevel

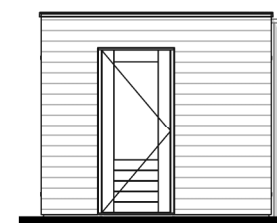

Linker zijgevel

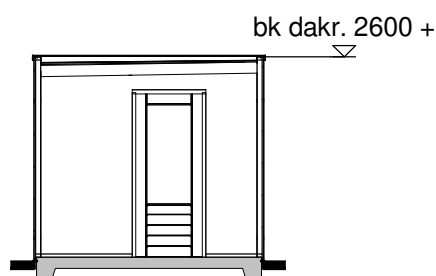

Doorsnede A

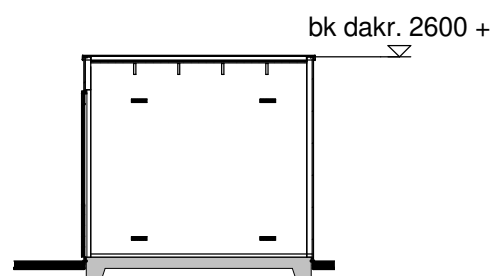

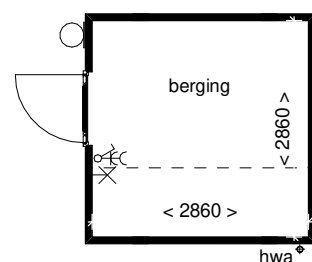

Doorsnede B







Begane grond

Renvooi

-  houten rabatdelen
-  houten wanden

Installaties

-  - enkelpolige schakelaar
-  - dubbele wandcontactdoos
-  - lichtpunt buiten
-  - lichtpunt aan wand

Disclaimer

De op deze tekening aangegeven maten zijn circa maten in millimeters en tussen de wanden / vloeren gemeten, waarbij geen rekening is gehouden met enige wandafwerking, plinten, aftimmering, etc. In verband met de nauwkeurige uitwerking van details, constructie, maatvoering, materialen e.d. kunnen er kleine afwijkingen ontstaan ten opzichte van de nu vermelde gegevens. Deze geringe afwijkingen geven geen aanleiding tot verrekening. Aan de op deze tekening aangegeven maten kunnen derhalve geen rechten worden ontleend. De op deze tekening aangegeven maatvoering is niet geschikt voor opdrachten aan derden door koper(s). De posities van aansluitingen en installatie onderdelen zijn indicatief op tekening aangegeven. De exacte aantallen en posities zullen na berekening in het werk door de installateurs worden bepaald en kunnen afwijken van deze tekening.

3D Impressie

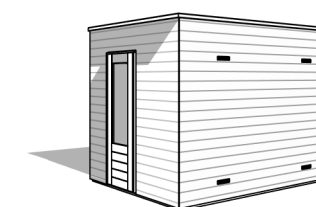

Tekening: Optie verbreden berging enkel, dubbel

Bouwnummer: 46-63,75-88,96-105, 117-138

Bladnummer: VT-00-B5-fase 2-3

Schaal: 1:100

Datum: 18-04-2023



Type: C57-1
Bouwnummer: 75

Type: C57-1
Bouwnummer: 76

Type: C57-4
Bouwnummer: 77

Type: C57-1
Bouwnummer: 78

Type: C57-4
Bouwnummer: 79

Type: C57-1
Bouwnummer: 80

Type: C57U-1
Bouwnummer: 81

Vorgevel



Type: C57U-1
Bouwnummer: 81

Type: C57-1
Bouwnummer: 80

Type: C57-4
Bouwnummer: 79

Type: C57-1
Bouwnummer: 78

Type: C57-4
Bouwnummer: 77

Type: C57-1
Bouwnummer: 76

Type: C57-1
Bouwnummer: 75

Achtergevel

**BENT
WIJCK**
BENTHUIZEN

Tekening: Gevels blok 17

Woningtype: C57-1/C57U-1,C57-4

Bouwnummer: 75 t/m 81

Bladnummer: VT-C17-00a

Schaal: 1:150

Datum: 18-04-2023

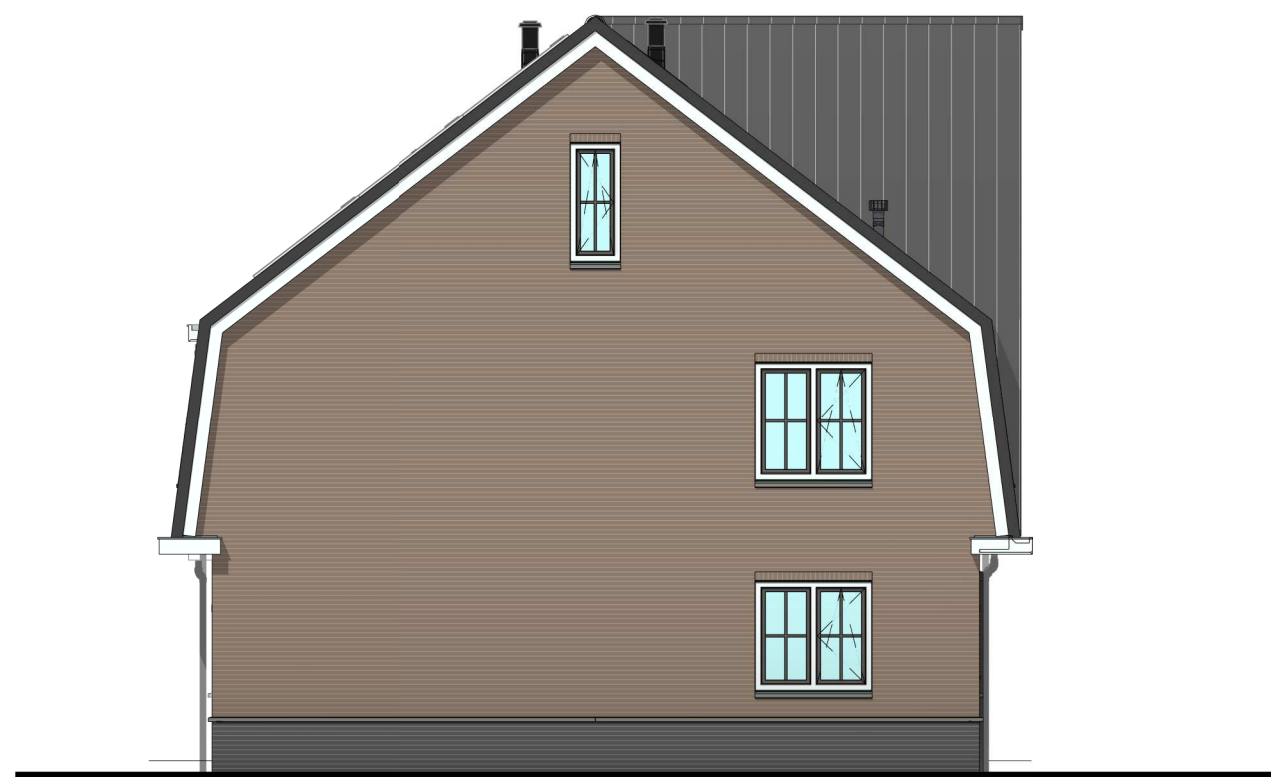

Linker zijgevel

Type: C57-1
Bouwnummer: 75



Rechter zijgevel

Type: C57U-1
Bouwnummer: 81



Tekening: Zijgevels blok 17
Woningtype: C57-1/C57U-1,C57-4
Bouwnummer: 75 t/m 81
Bladnummer: VT-C17-00b
Schaal: 1:100
Datum: 18-04-2023

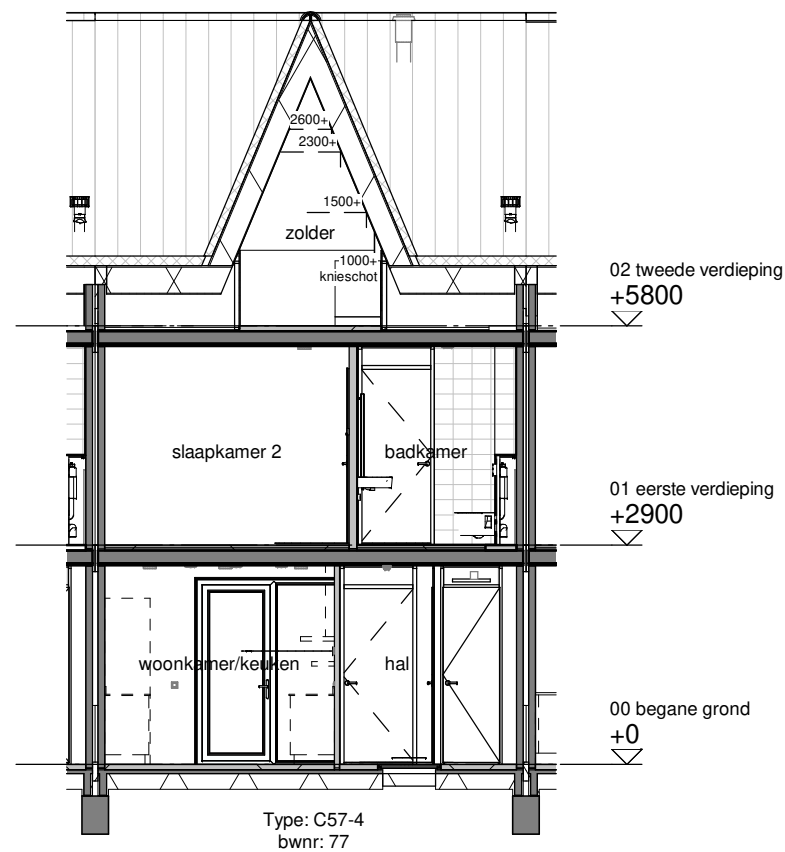

Doorsnede A

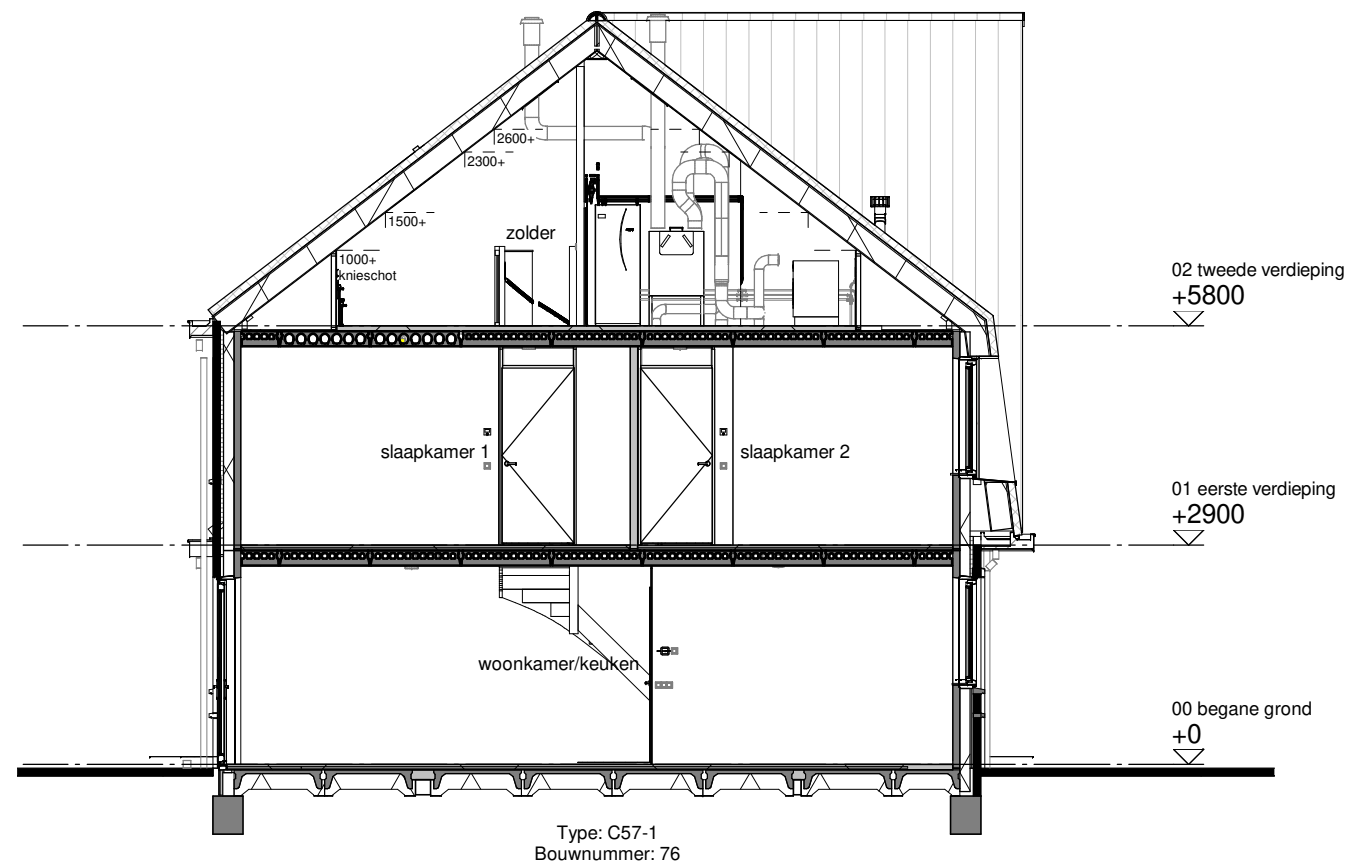

Doorsnede B

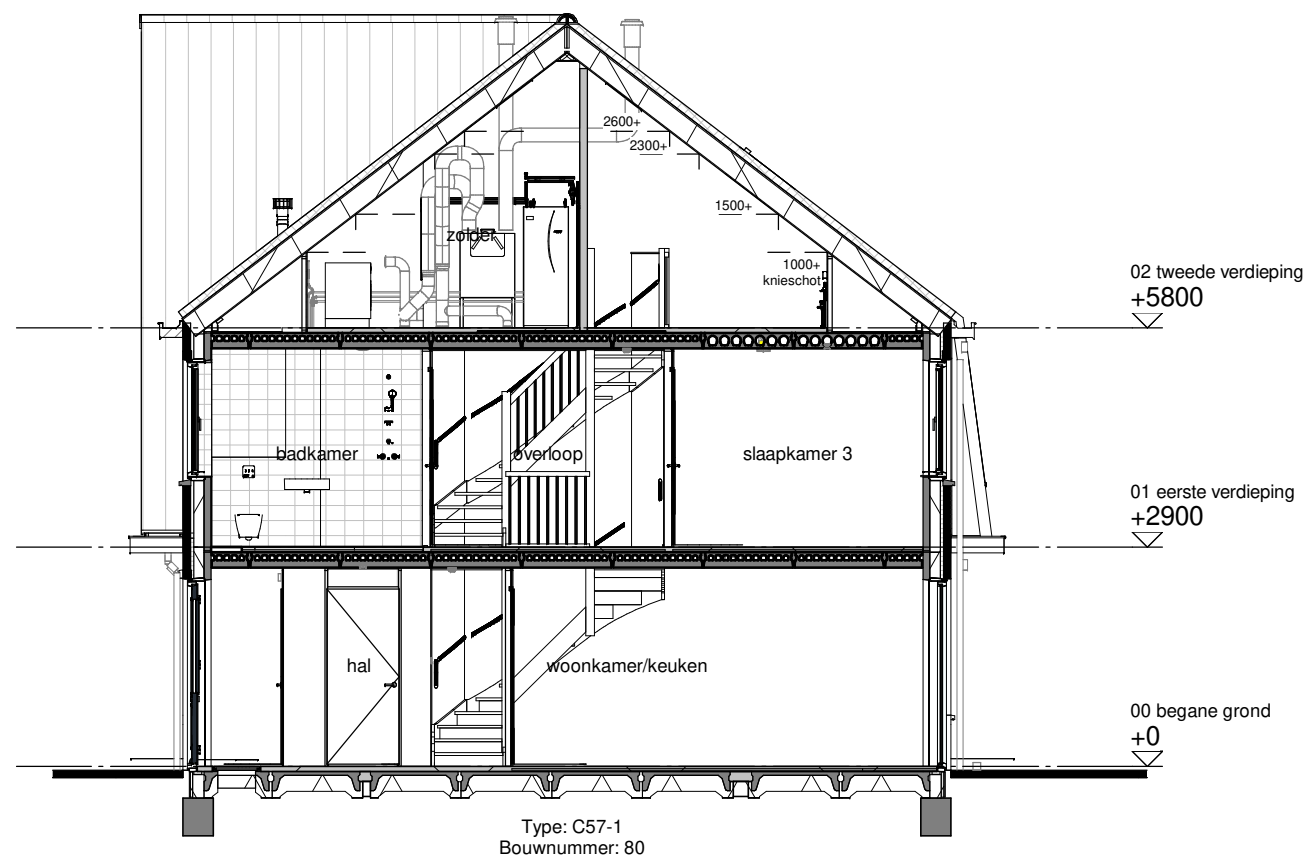

Doorsnede C

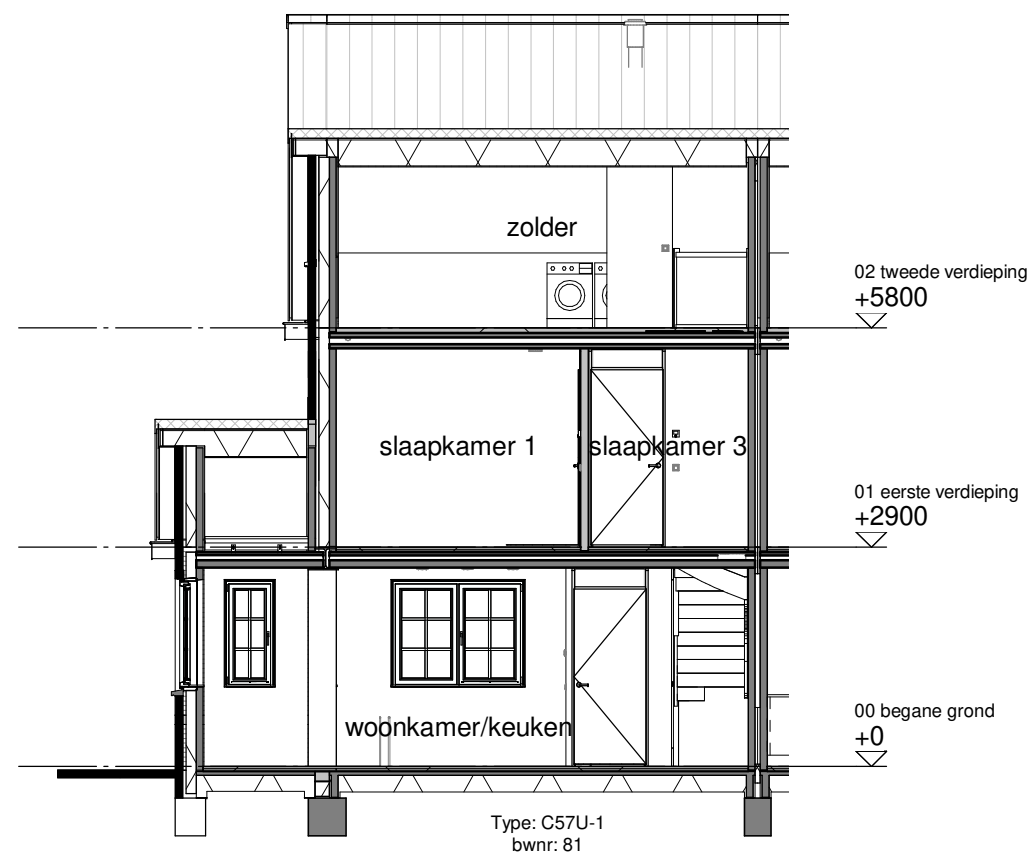

Doorsnede D

**BENT
WIJCK**
BENTHUIZEN

Tekening: Doorsneden blok 17

Woningtype: C57-1/C57U-1,C57-4

Bouwnummer: 75 t/m 81

Bladnummer: VT-C17-00c

Schaal: 1:100

Datum: 18-04-2023

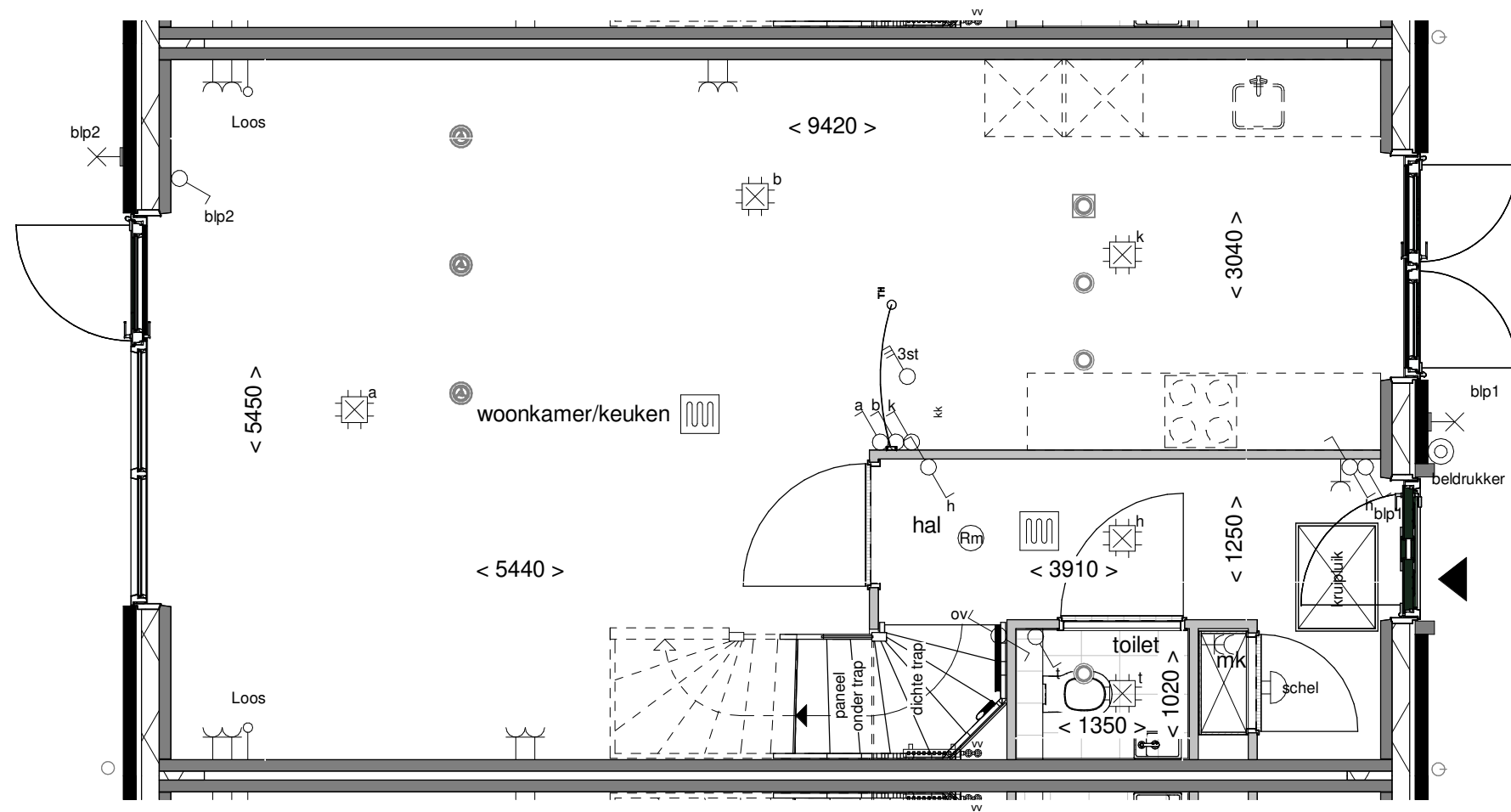

Tekening: Begane grond

Woningtype: C57-4

Bouwnummer: 79

Bladnummer: VT-C-79a

Schaal: 1:50

Datum: 18-04-2023

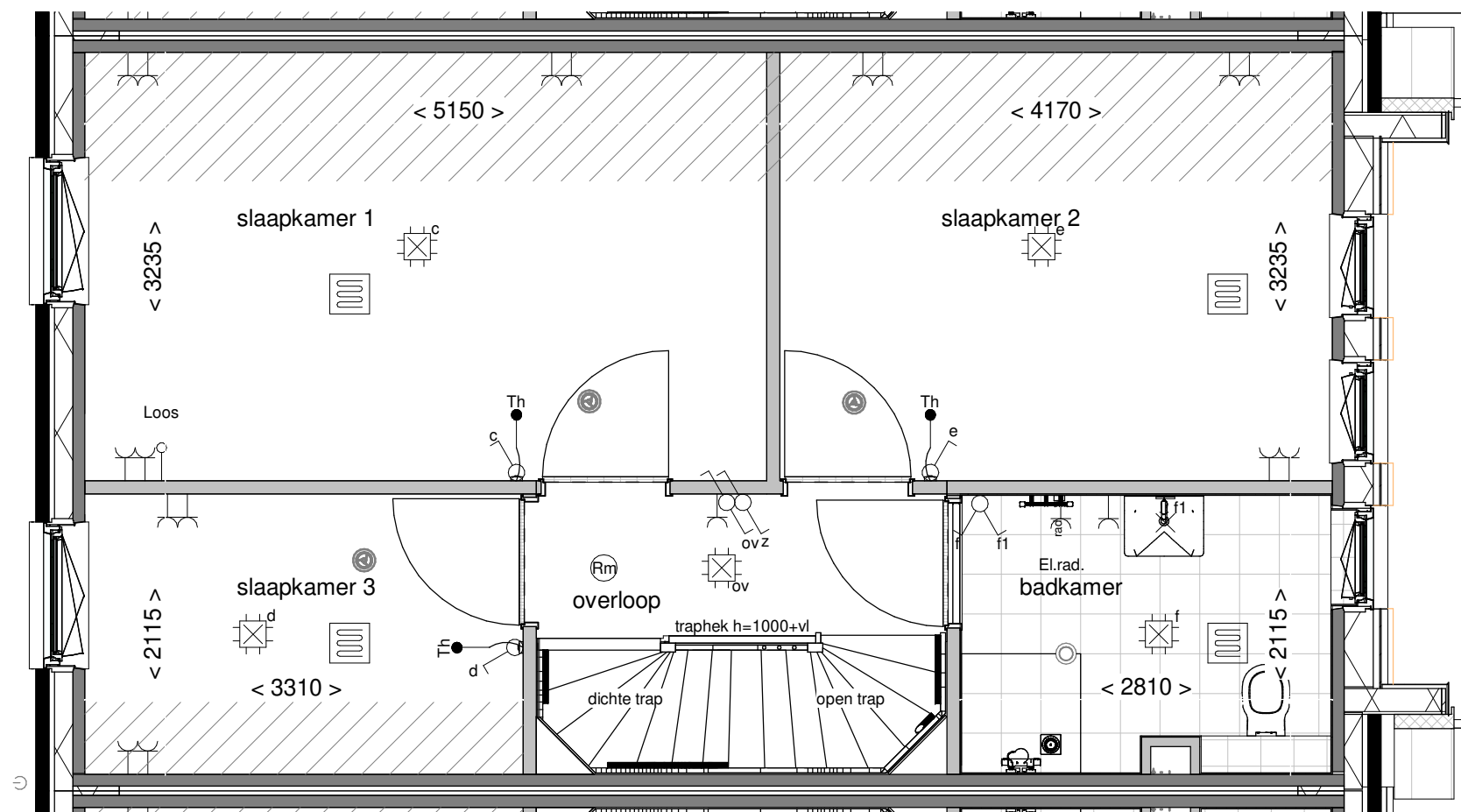

Tekening: **Eerste verdieping**

Woningtype: **C57-4**

Bouwnummer: **79**

Bladnummer: **VT-C-79b**

Schaal: **1:50**

Datum: **18-04-2023**

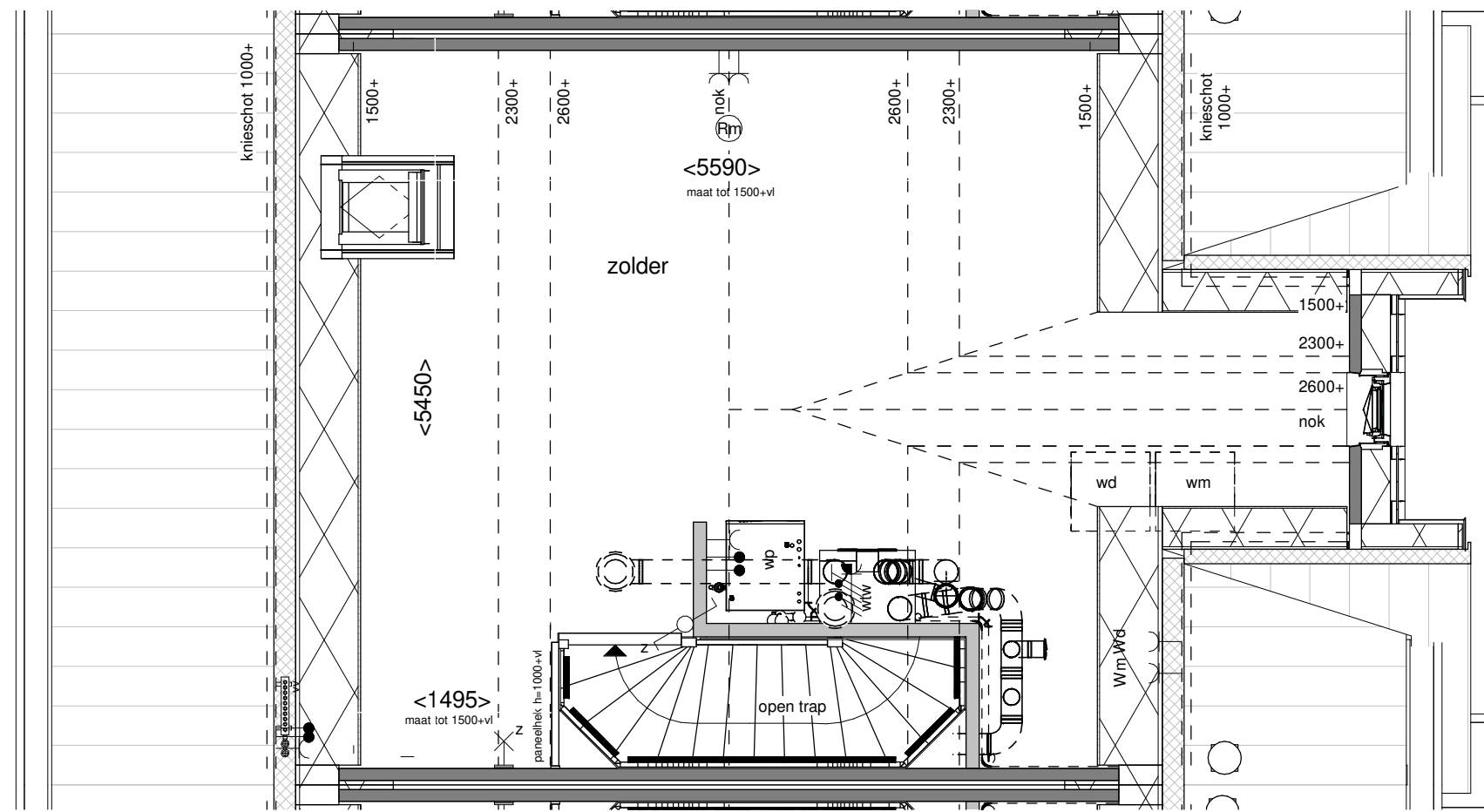

Tekening: Tweede verdieping

Woningtype: C57-4

Bouwnummer: 79

Bladnummer: VT-C-79c

Schaal: 1:50

Datum: 18-04-2023

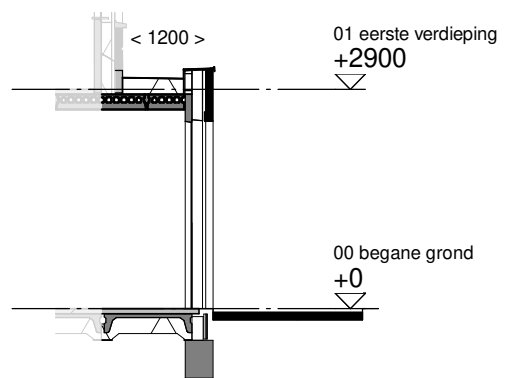
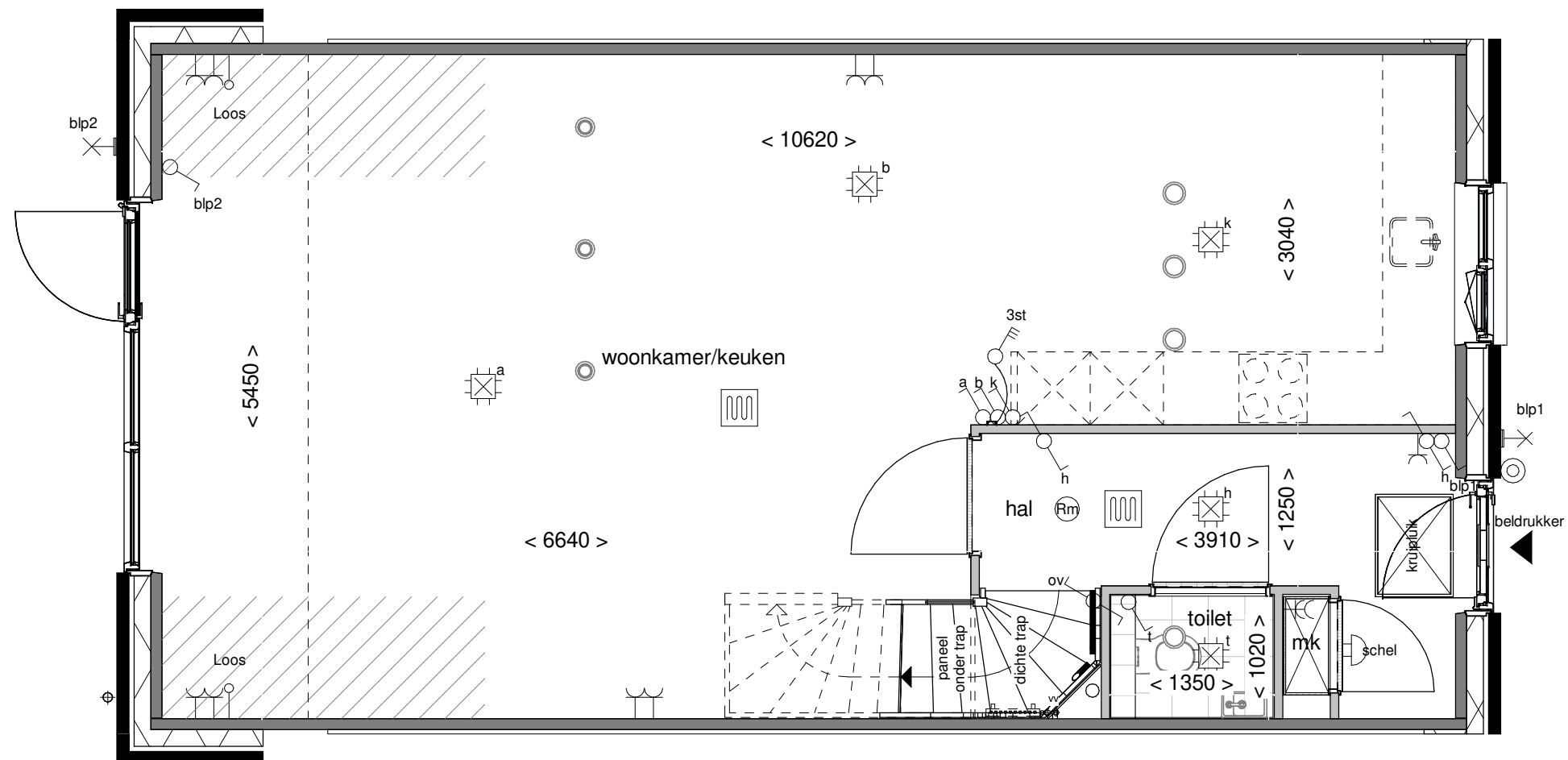

Doorsnede schaal 1:100



Achtergevel schaal 1:100

**BENT
WIJCK**
BENTHUIZEN

Optie: **Uitbouw achtergevel
120cm**

Woningtype: **C57**

Bouwnummer: -

Optienummer: **1.A.X.18**

Schaal: **1:50 / 1:100**

Datum: **18-04-2023**

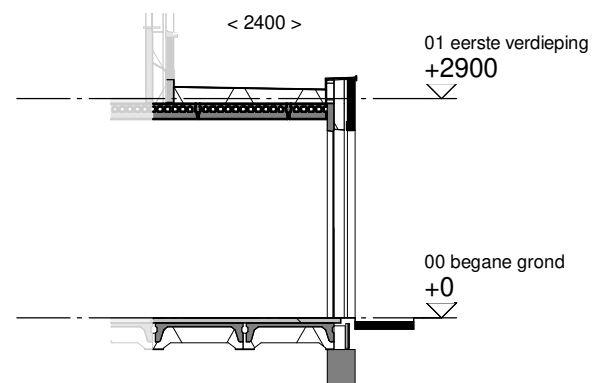
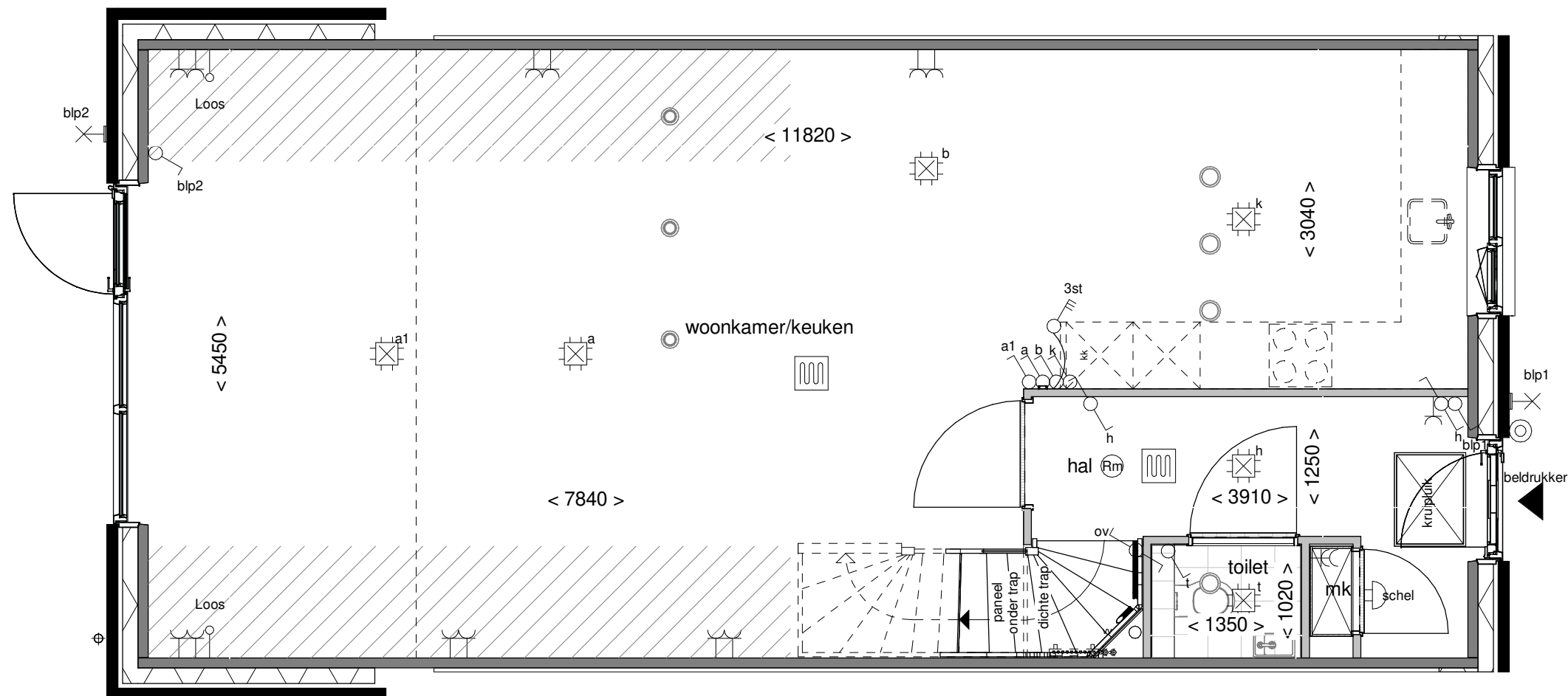

Doorsnede schaal 1:100



Achtergevel schaal 1:100

**BENT
WIJCK**
BENTHUIZEN

Optie: **Uitbouw achtergevel
240cm**

Woningtype: **C57**

Bouwnummer: -

Optienummer: **1.A.X.38**

Schaal: **1:50 / 1:100**

Datum: **18-04-2023**

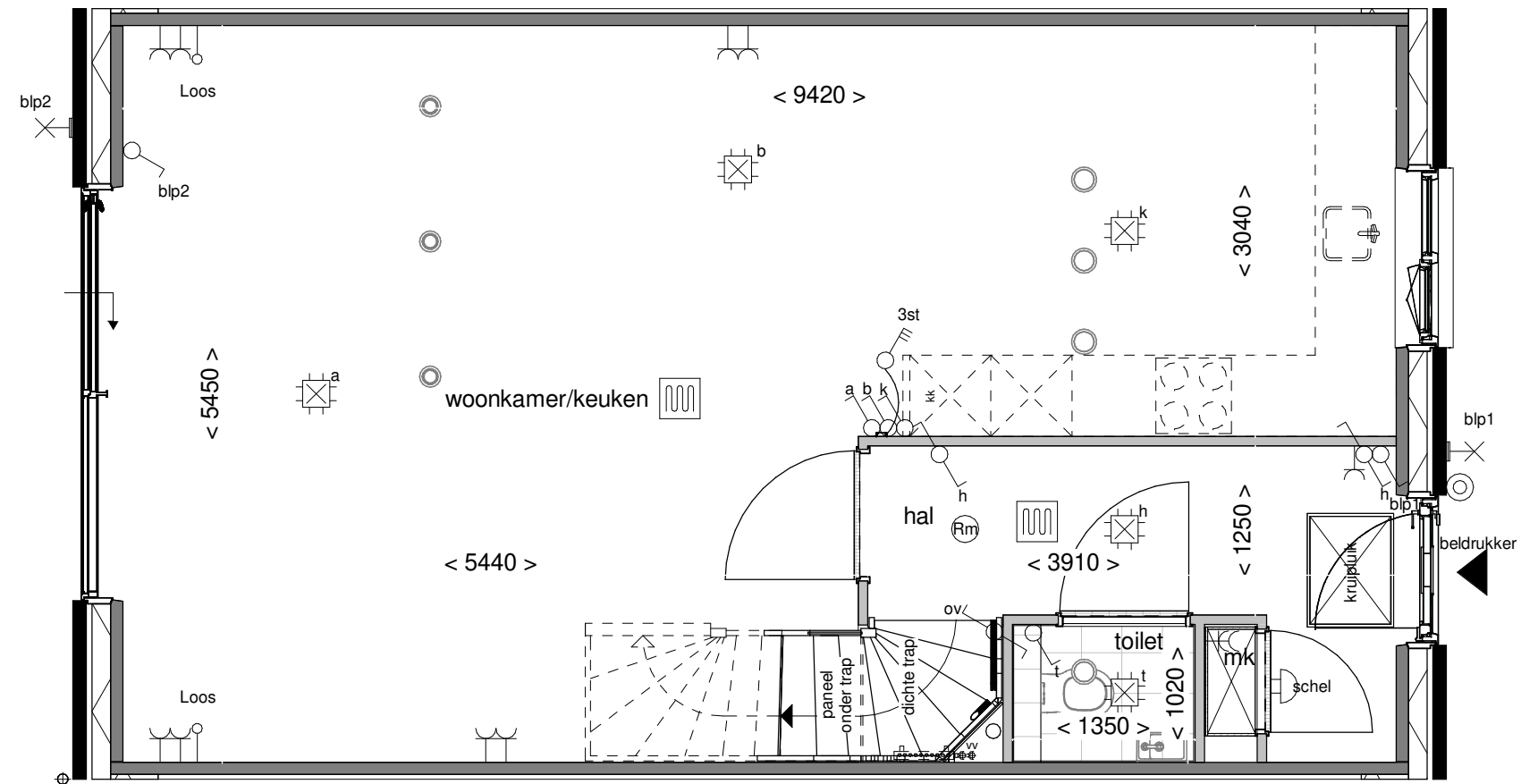

Achtergevel schaal 1:100



Optie: Aluminium schuifpui

Woningtype: C57

Bouwnummer: -

Optienummer: 1.A.X.52

Schaal: 1:50 / 1:100

Datum: 18-04-2023

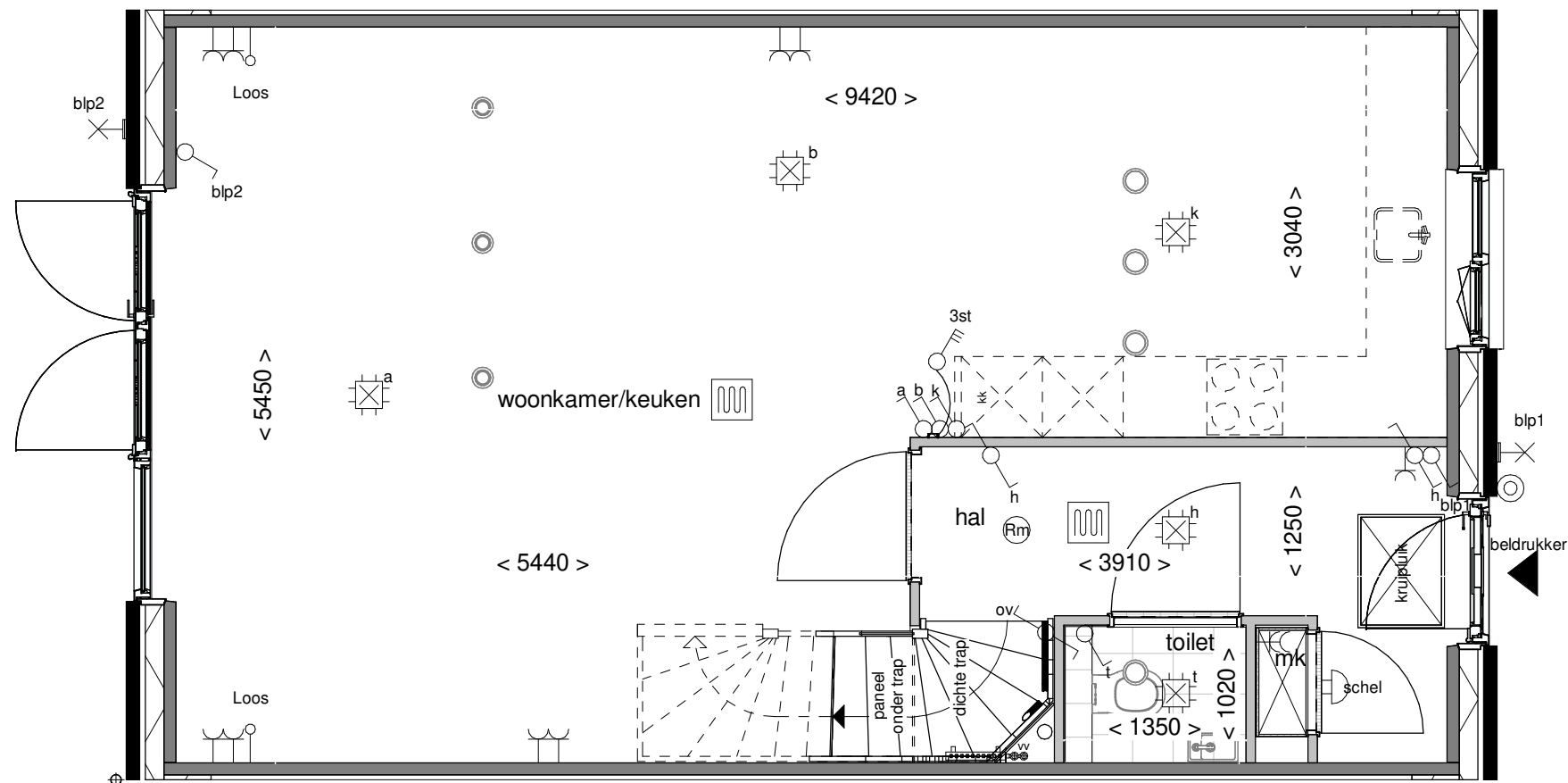

Achtergevel schaal 1:100

**BENT
WIJCK**
BENTHUIZEN

Optie: **Openslaande deuren met 1 zijlicht**

Woningtype: **C57**

Bouwnummer: -

Optienummer: **1.A.X.58**

Schaal: **1:50 / 1:100**

Datum: **18-04-2023**

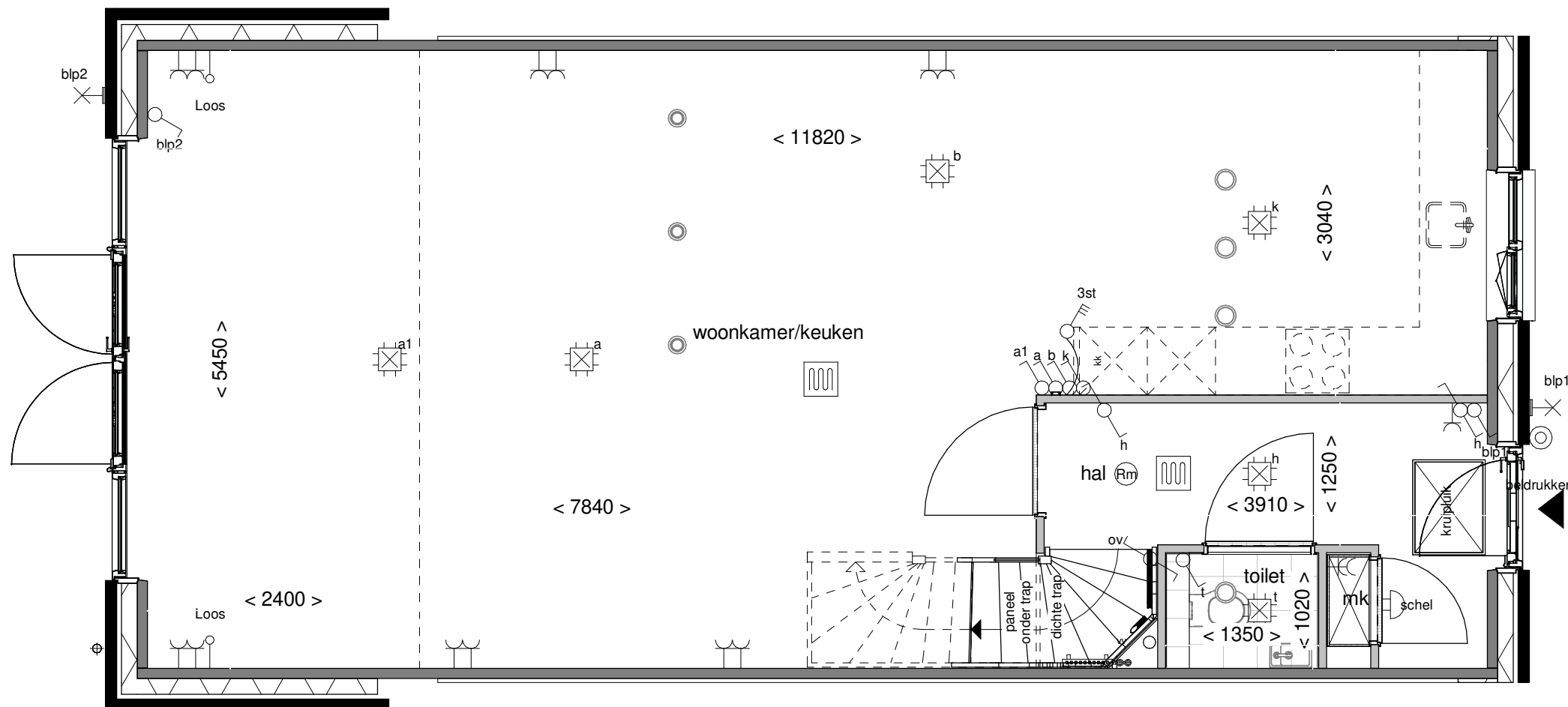

Achtergevel schaal 1:100

**BENT
WIJCK**
BENTHUIZEN

Optie: Openslaande deuren met 2 zijlichten

Woningtype: C57

Bouwnummer: -

Optienummer: 1.A.X.62

Schaal: 1:50 / 1:100

Datum: 18-04-2023

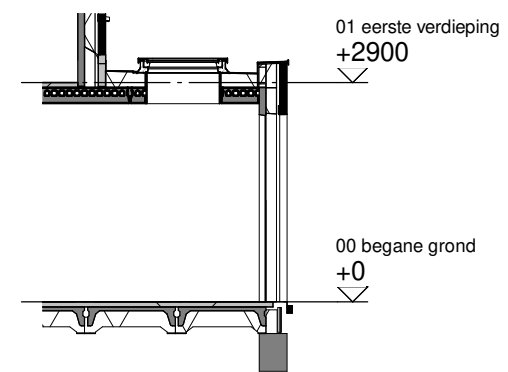
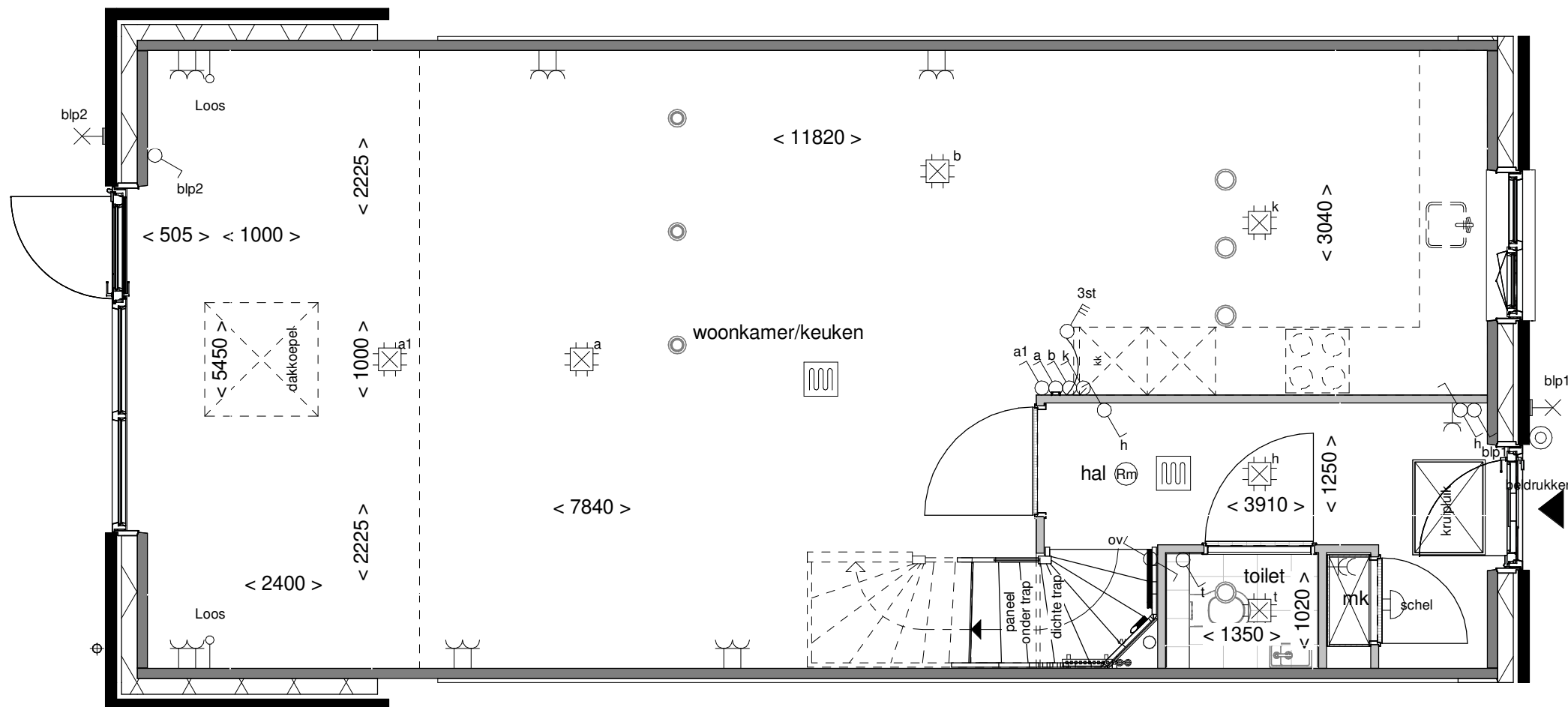

Doorsnede schaal 1:100

**BENT
WIJCK**
BENTHUIZEN

Optie: Lichtkoopeel in uitbouw 240cm

Woningtype: C57

Bouwnummer: -

Optienummer: 1.B.X.10

Schaal: 1:50 / 1:100

Datum: 18-04-2023

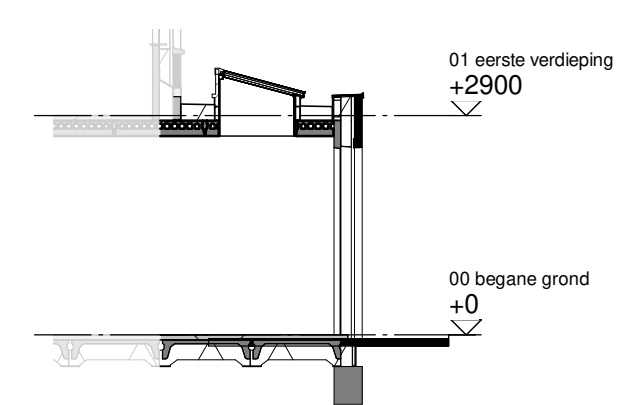
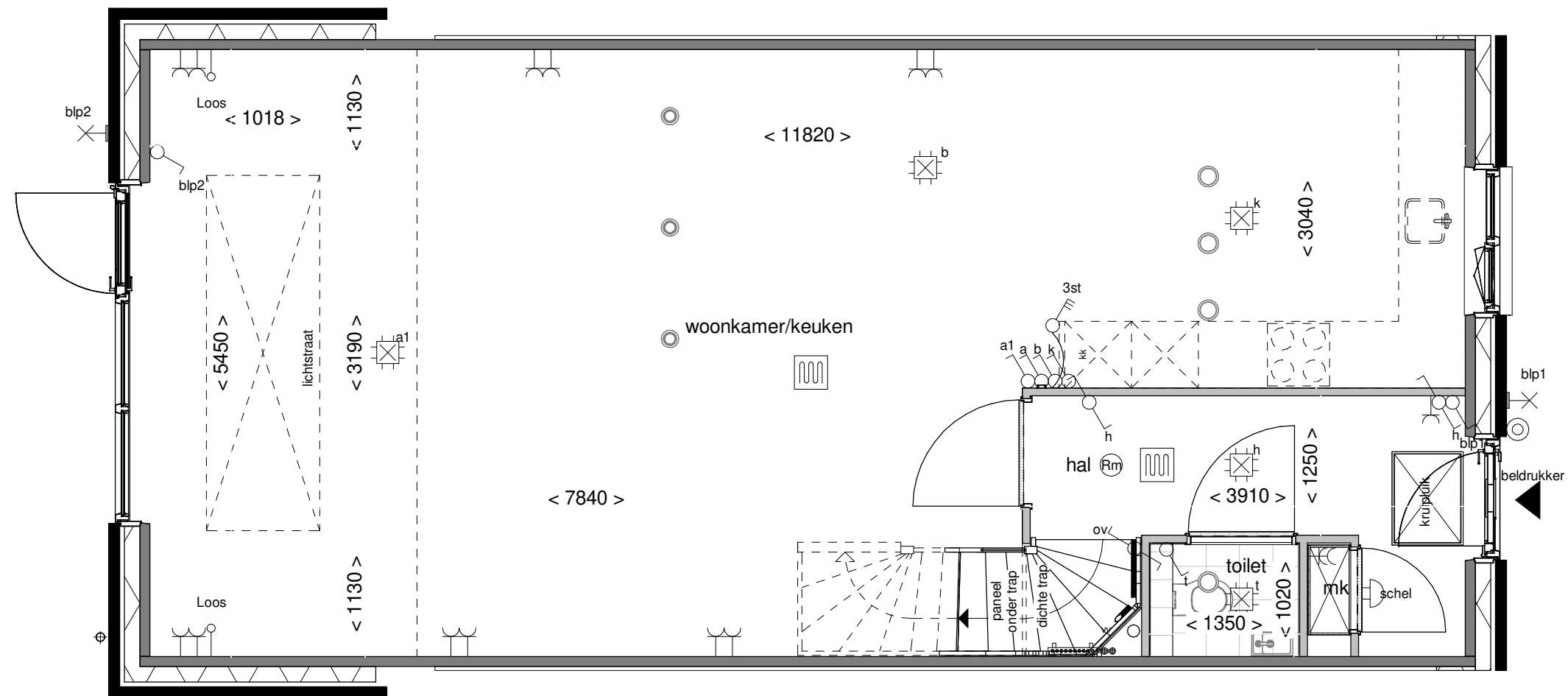

Doorsnede schaal 1:100



Optie: Lichtstraat in uitbouw 240cm

Woningtype: C57

Bouwnummer: -

Optienummer: 1.B.X.14

Schaal: 1:50 / 1:100

Datum: 18-04-2023

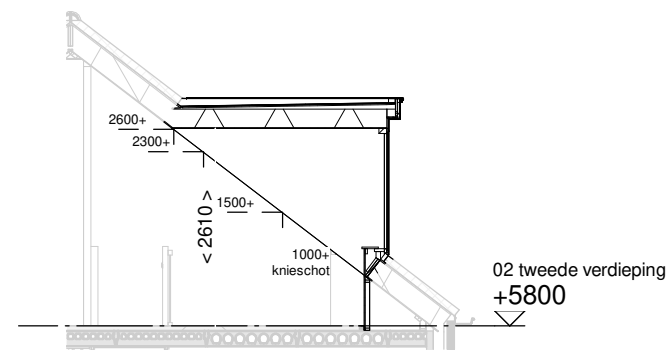
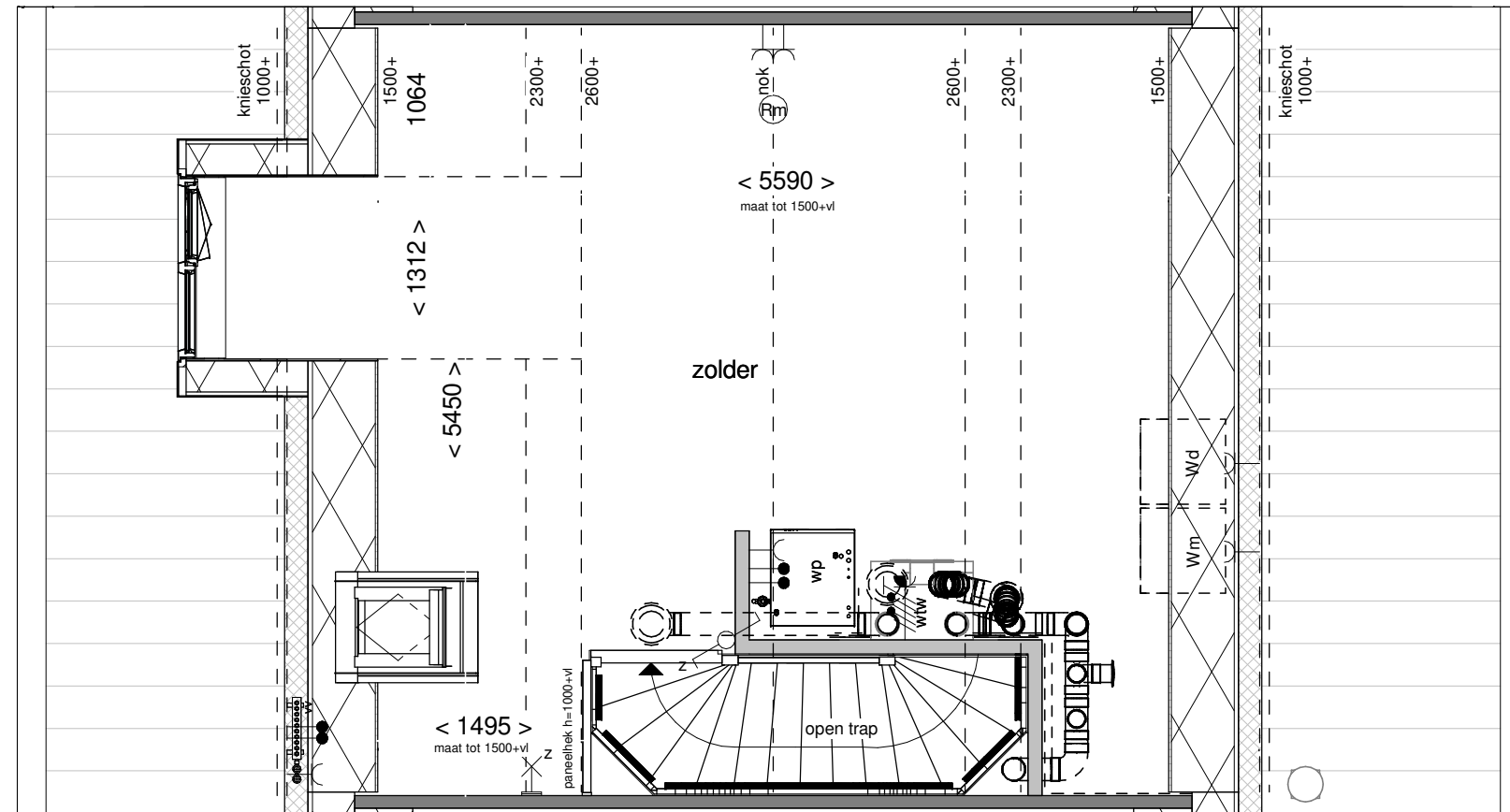

Doorsnede schaal 1:100



Achtergevel schaal 1:100

**BENT
WIJCK**
BENTHUIZEN

Optie: Dakkapel
achtergevel 130cm

Woningtype: C57

Bouwnummer: -

Optienummer: 1.B.X.32

Schaal: 1:50 / 1:100

Datum: 18-04-2023

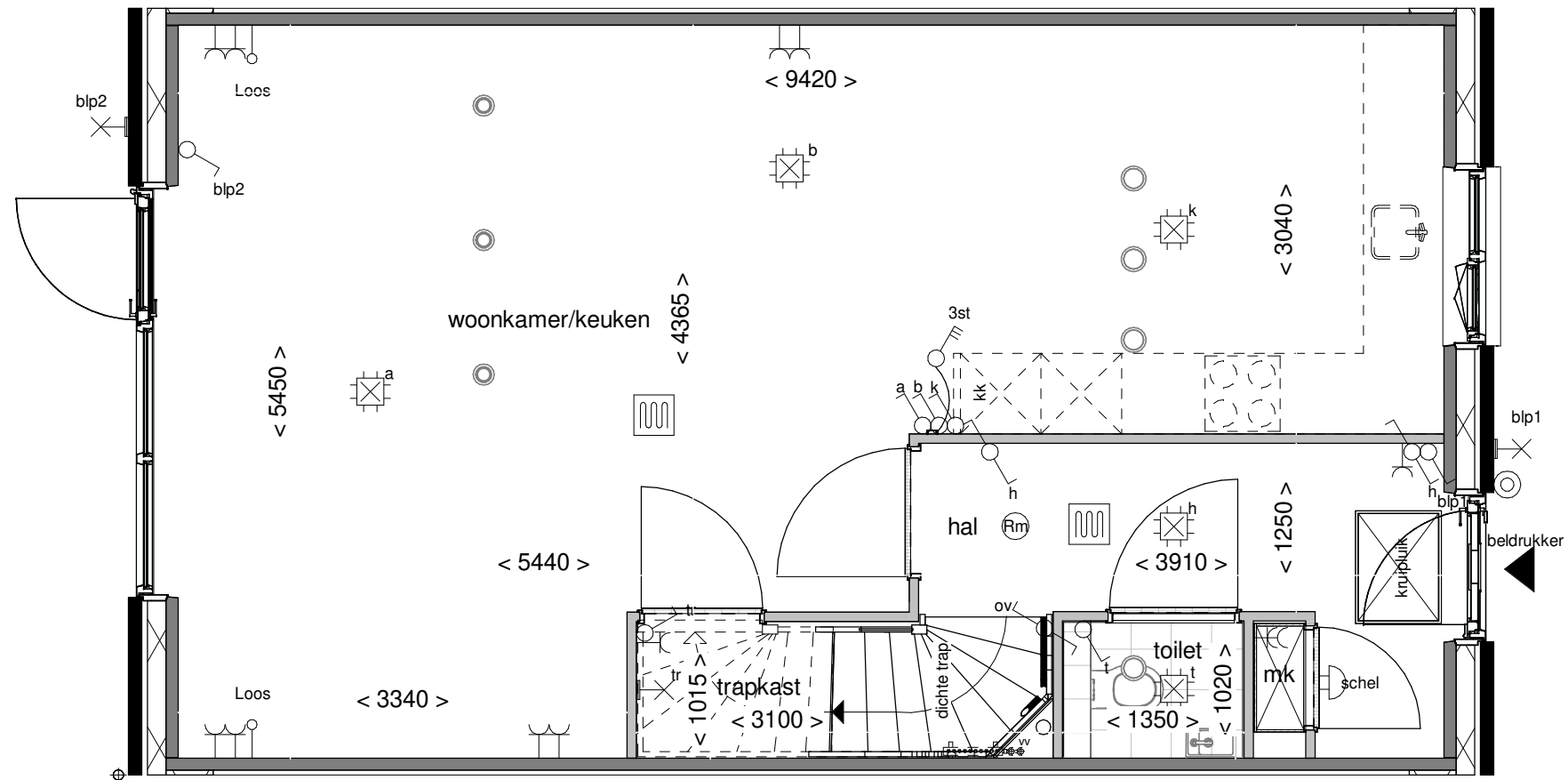

Optie: **Trapkast**

Woningtype: **C57**

Bouwnummer: -

Optienummer: **1.C.C.10**

Schaal: **1:50**

Datum: **18-04-2023**

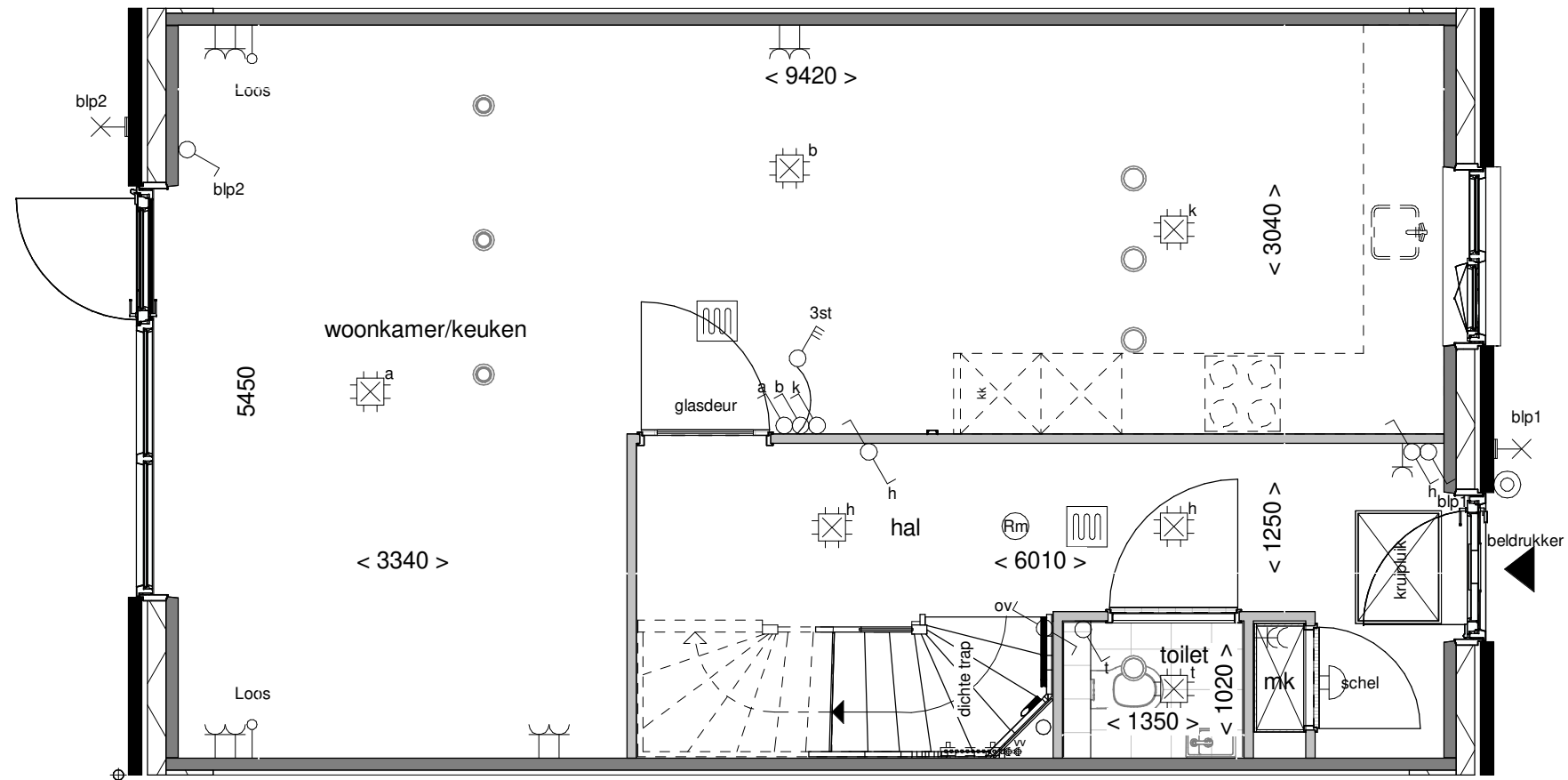

Optie: Vergroten hal met glasdeur

Woningtype: C57

Bouwnummer: -

Optienummer: 1.C.C.12

Schaal:

Datum: 18-04-2023

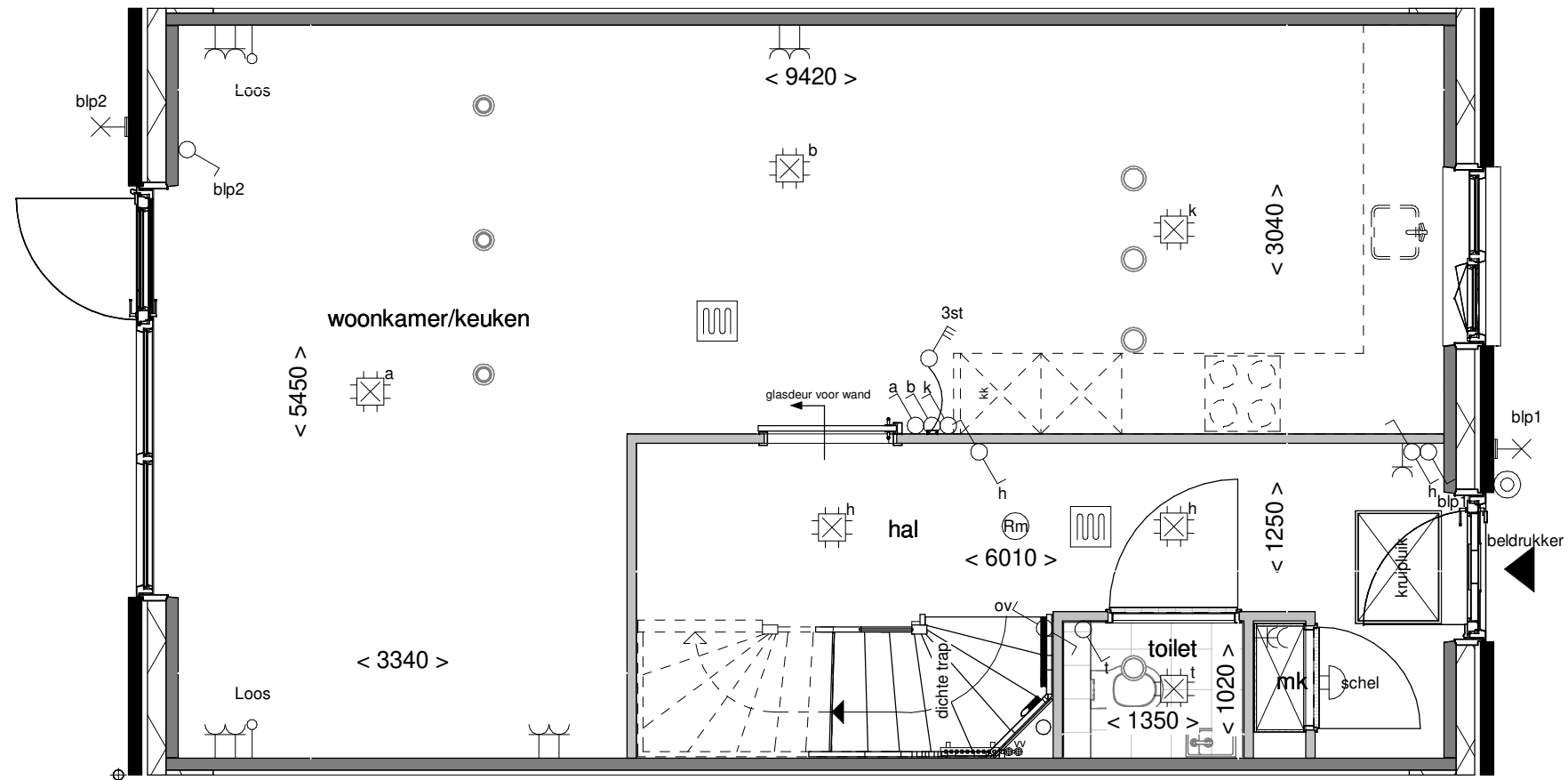

Optie: **Schuifdeur voor de wand**

Woningtype: **C57**

Bouwnummer: -

Optienummer: **1.C.C.12 - 2.L.0.24**

Schaal: **1:50**

Datum: **18-04-2023**

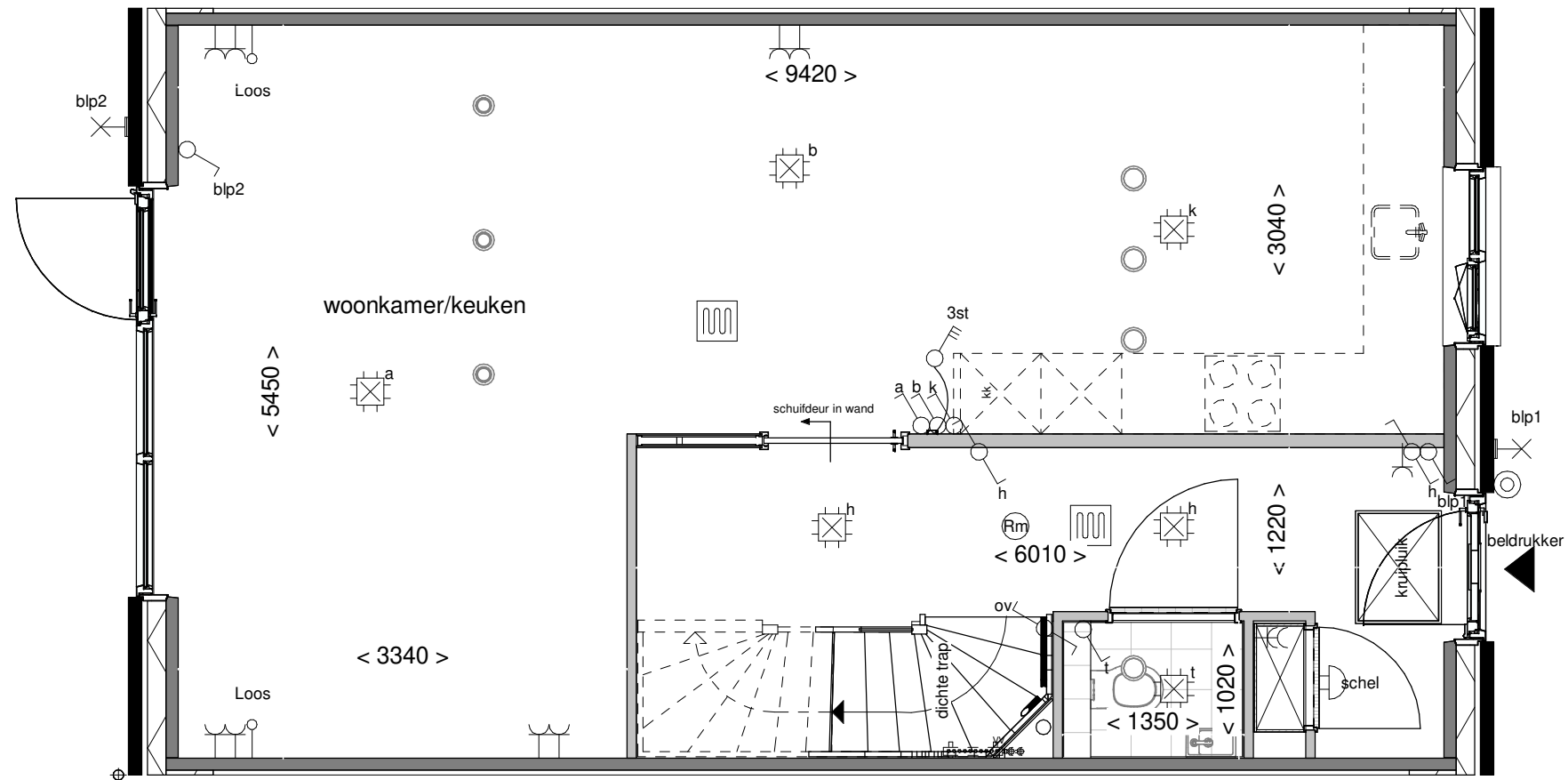

Optie: **Schuifdeur in de wand**

Woningtype: **C57**

Bouwnummer: -

Optienummer: **1.C.C.12 - 2.L.0.26**

Schaal: **1:50**

Datum: **18-04-2023**

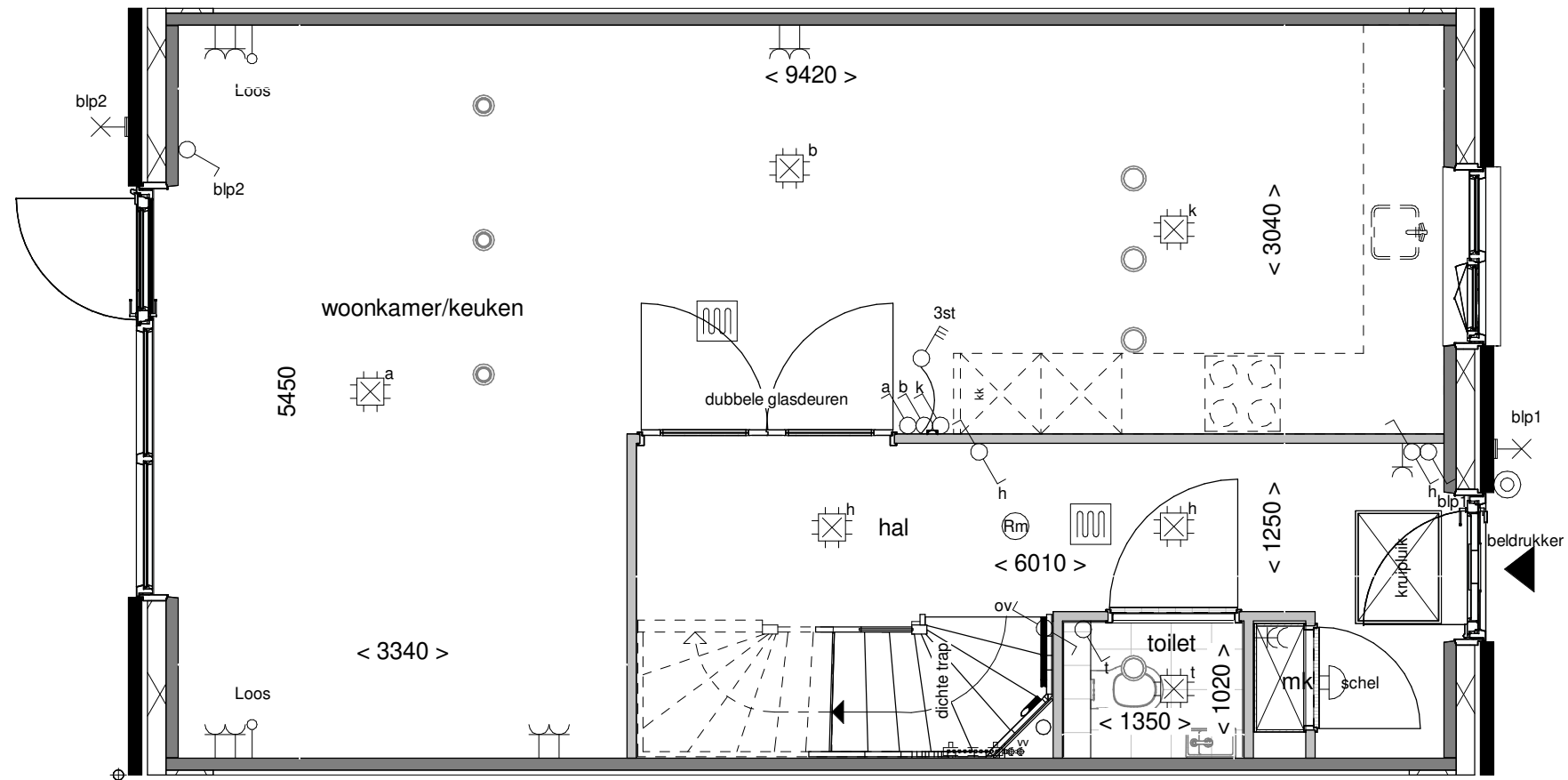

Optie: Vergroten hal met
2 glasdeuren

Woningtype: C57

Bouwnummer: -

Optienummer: 1.C.C.14

Schaal: 1:50

Datum: 18-04-2023

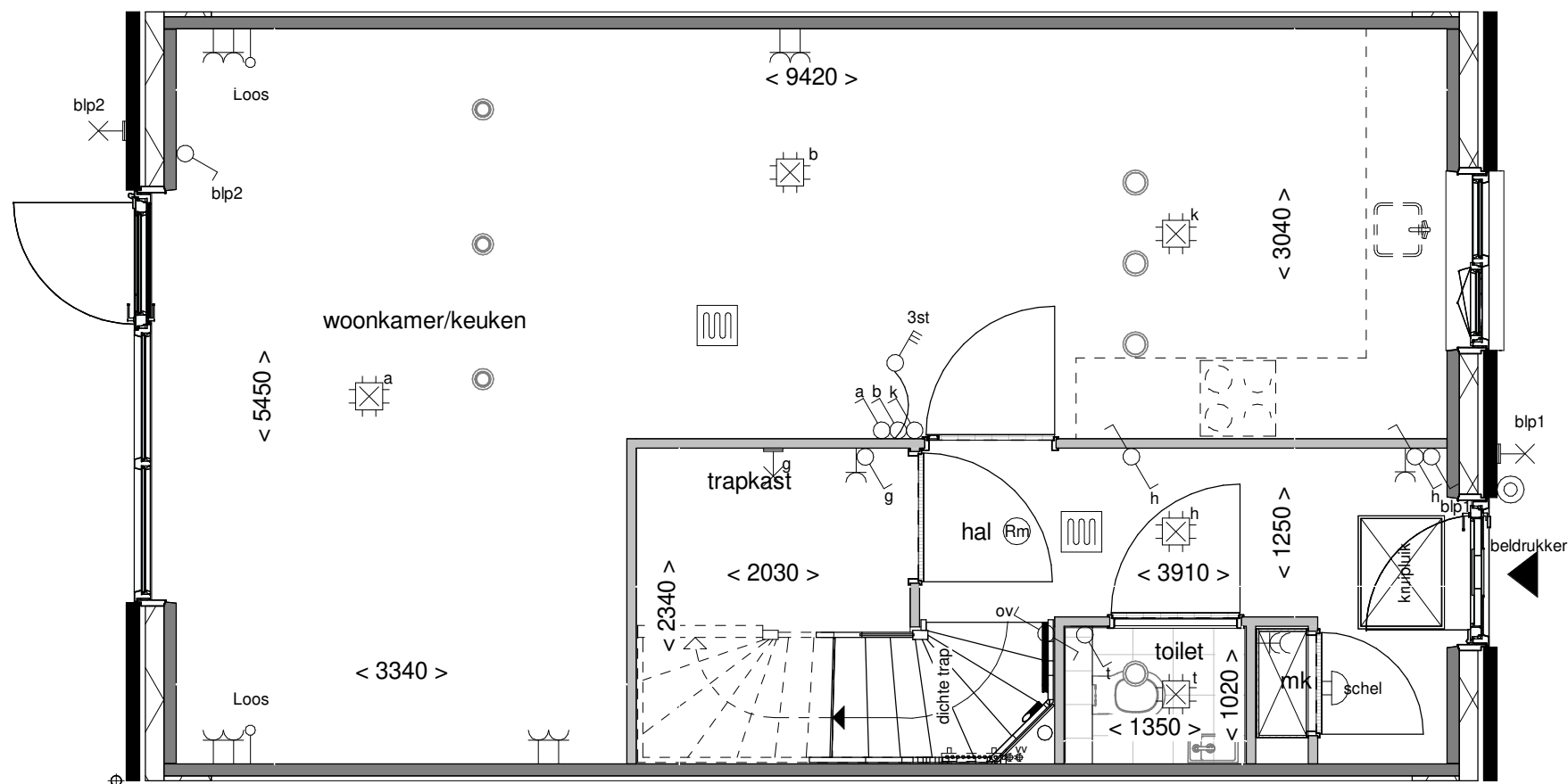



BENT

WIJCK

 BENTHUIZEN

Optie: Vergroten trapkast

Woningtype: C57

Bouwnummer: -

Optienummer: 1.C.C.16

Schaal: 1:50

Datum: 18-04-2023

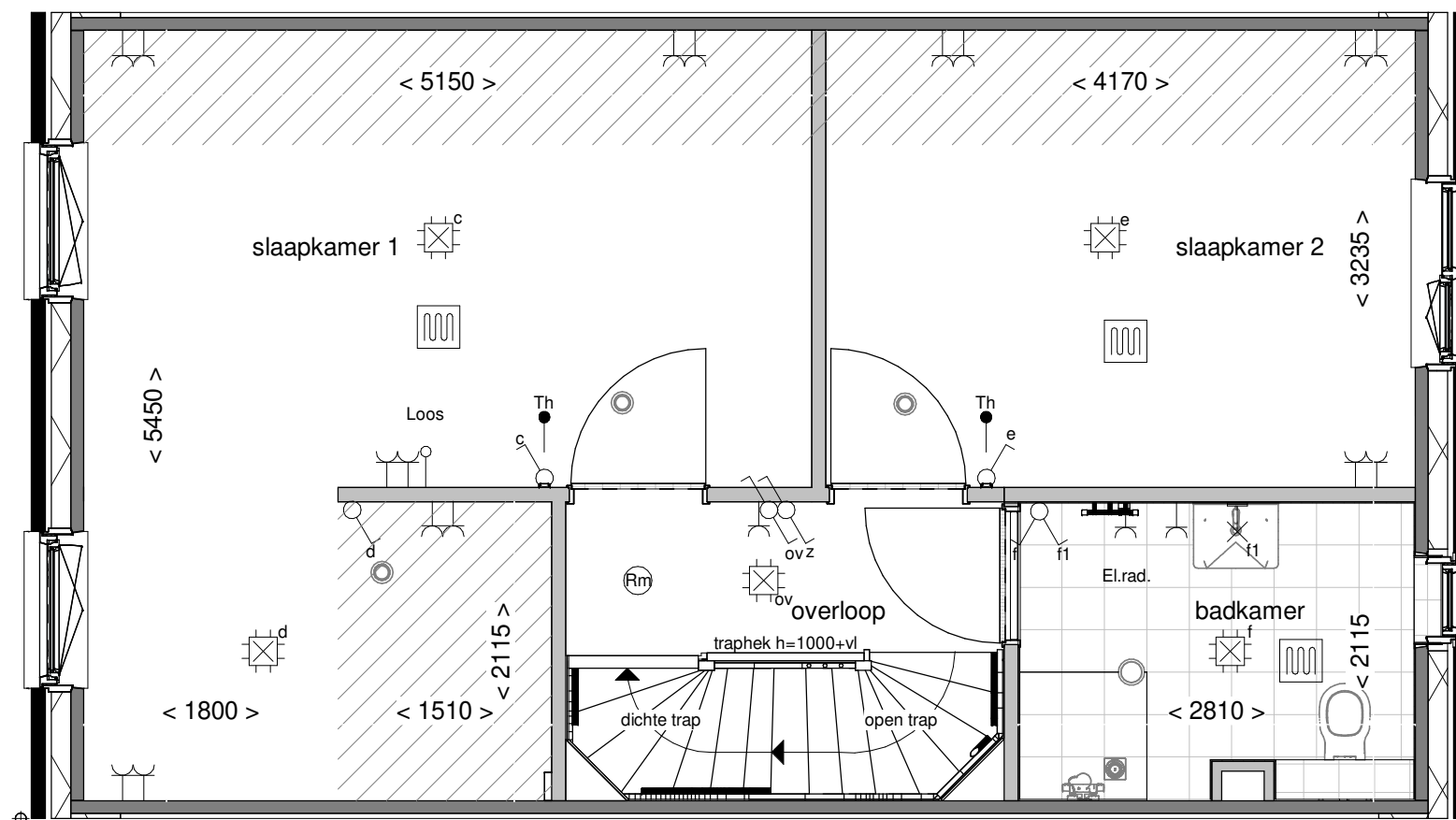

Optie: Slaapkamer 3
wijzigen in inloopkast

Woningtype: C57

Bouwnummer: -

Optienummer: 1.C.C.30

Schaal: 1:50

Datum: 18-04-2023

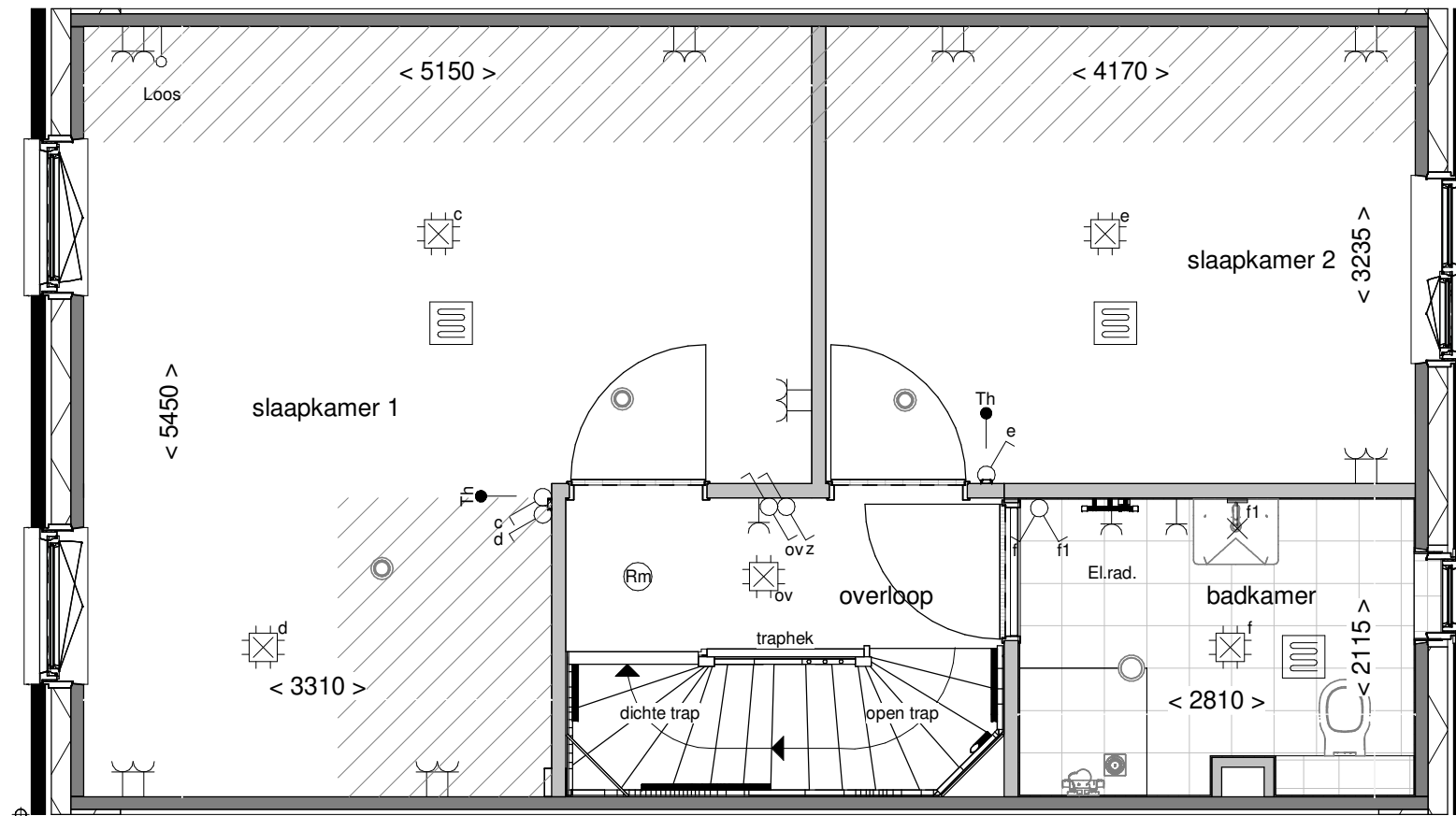

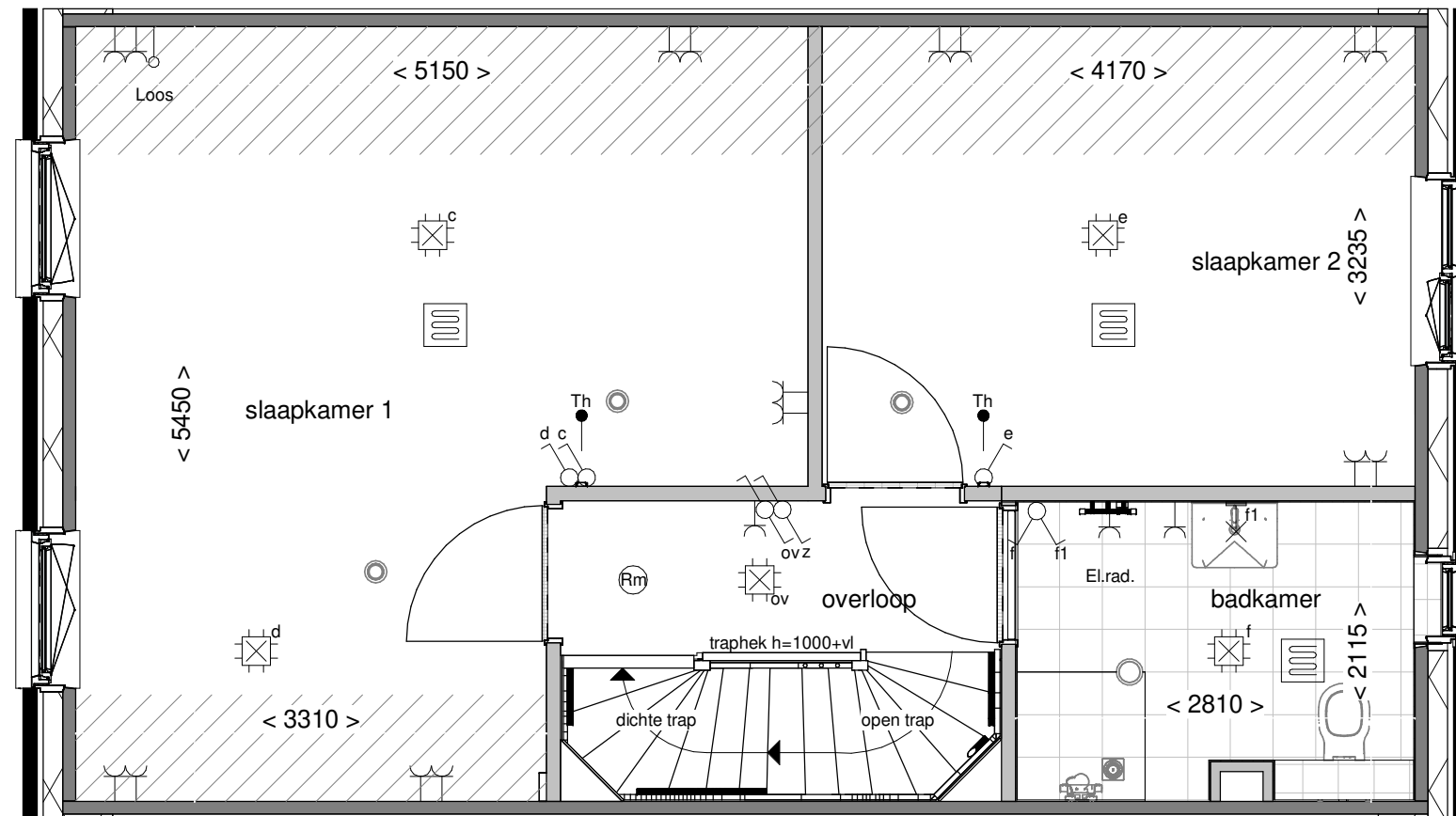

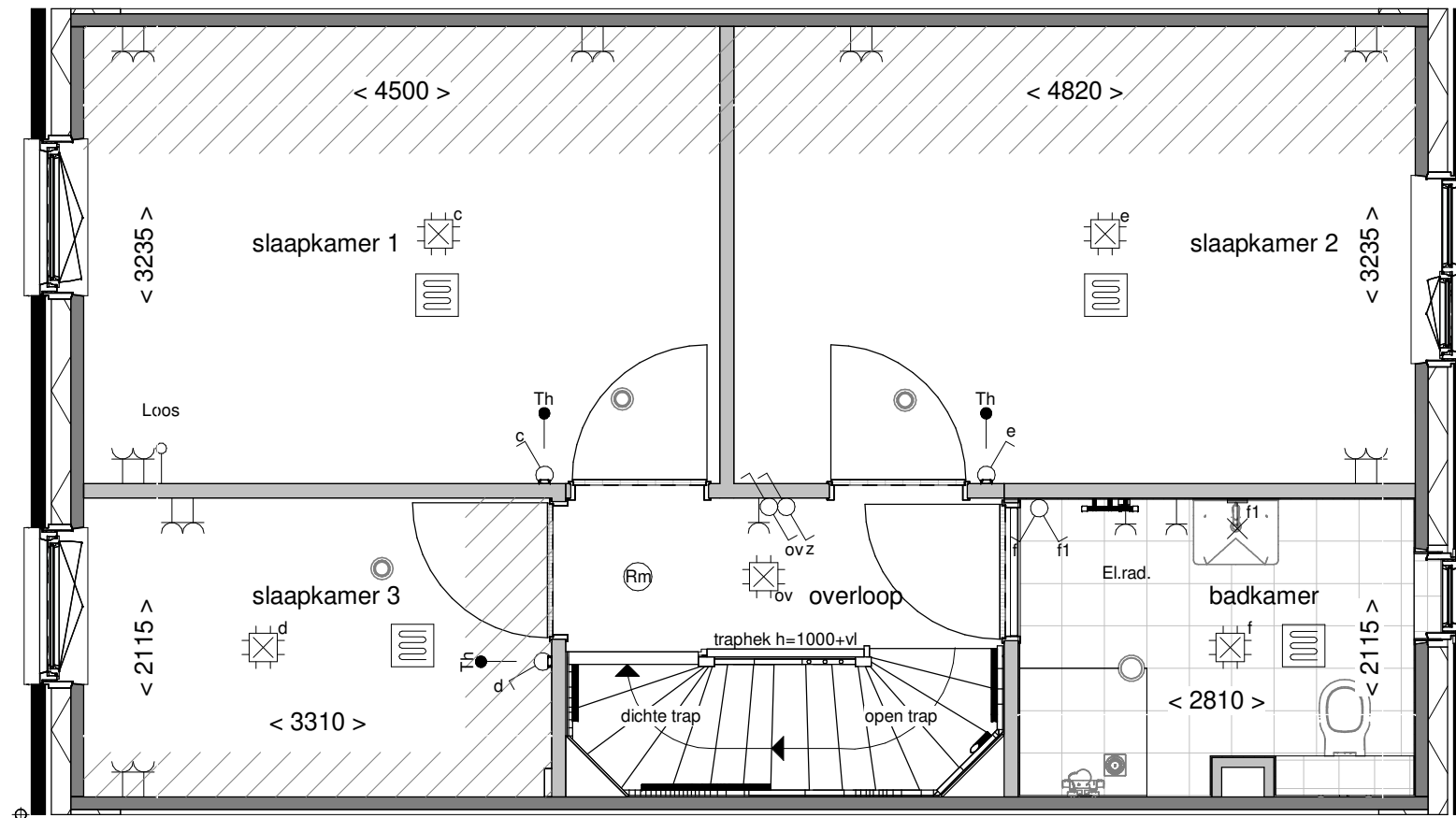

Optie: Vergroten
slaapkamer 2 en 3

Woningtype: C57

Bouwnummer: -

Optienummer: 1.C.C.34

Schaal: 1:50

Datum: 18-04-2023

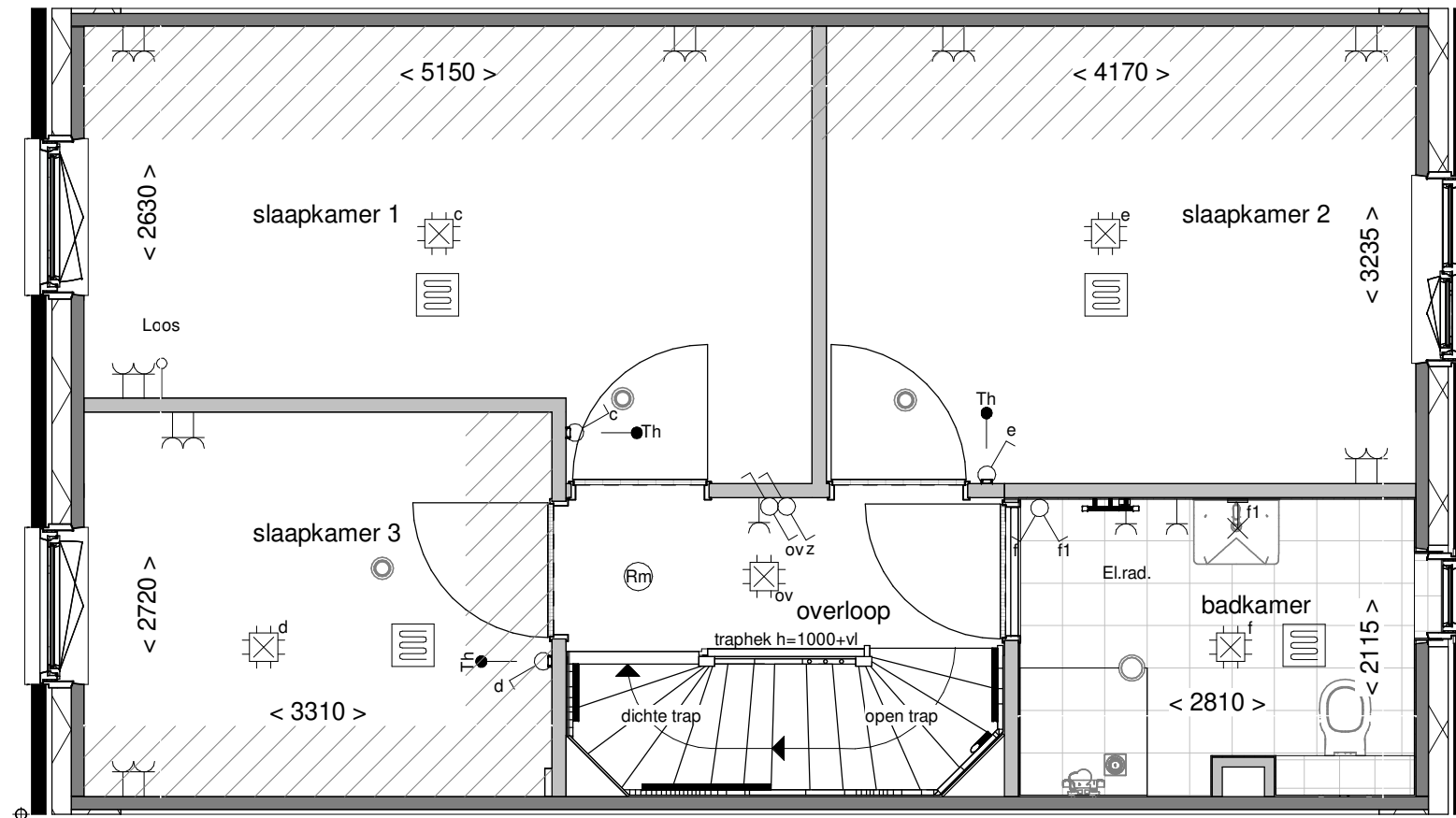

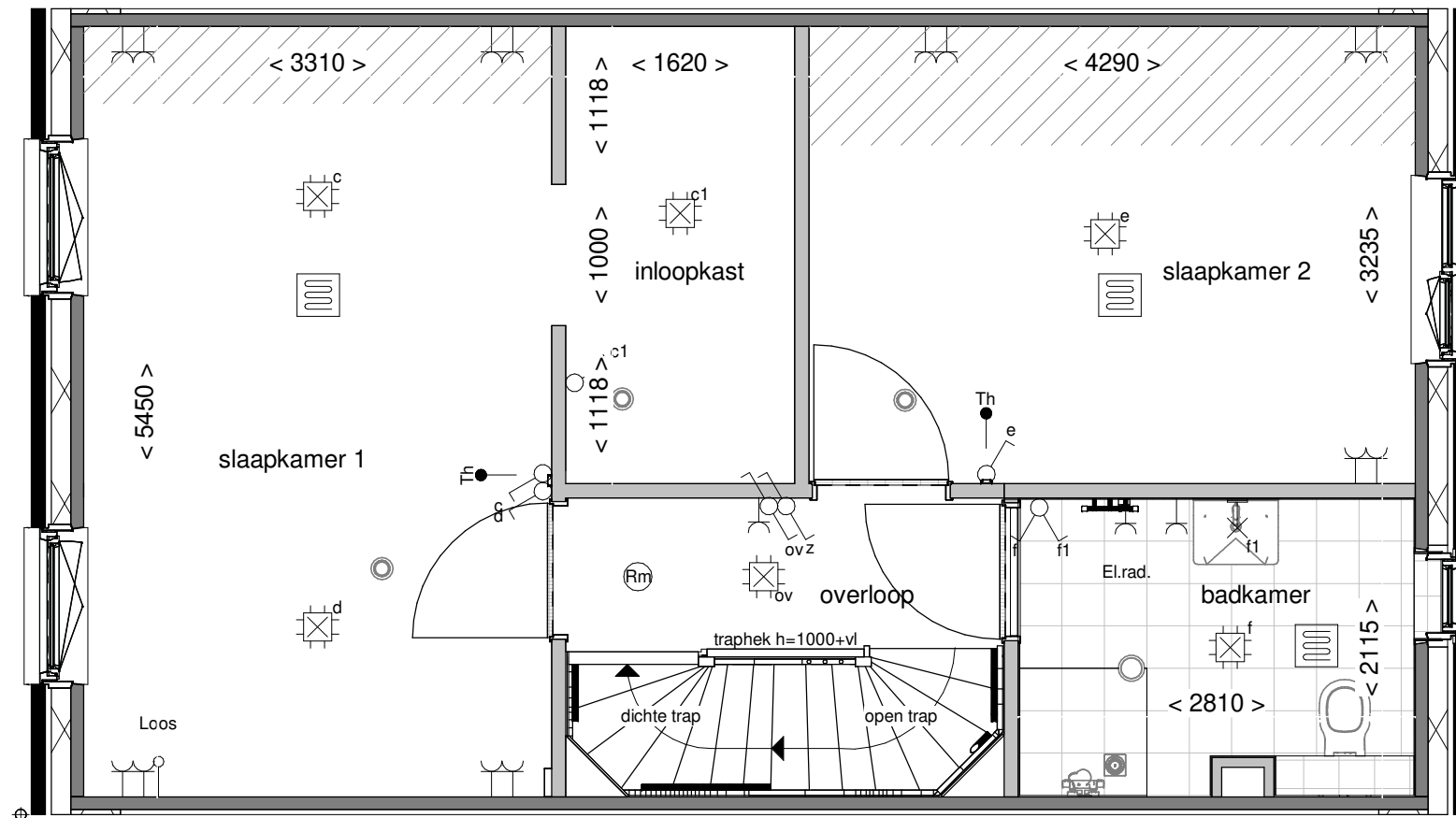

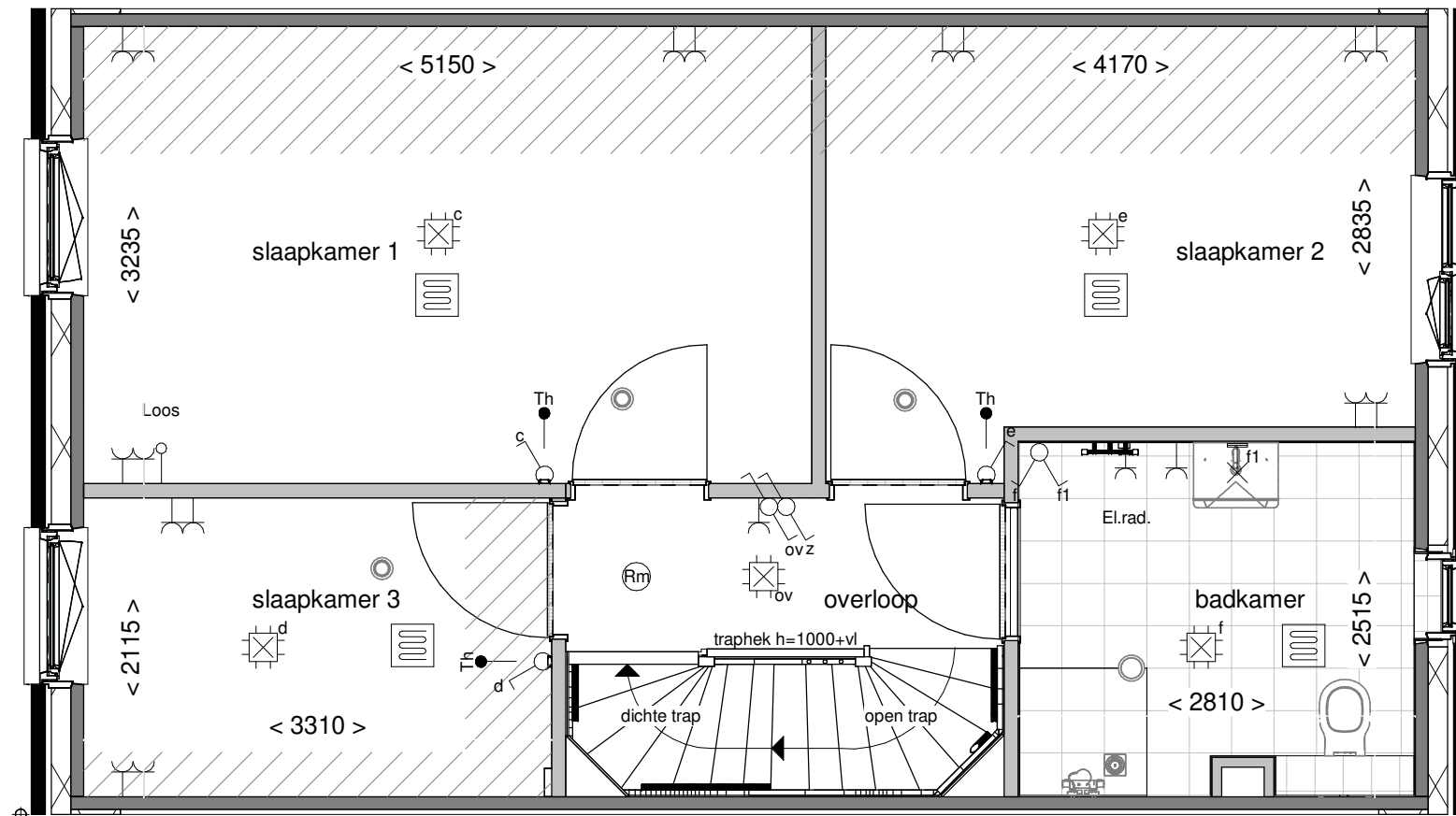

Optie: Vergroten badkamer met ca. 40cm

Woningtype: C57

Bouwnummer: -

Optienummer: 1.C.C.40

Schaal: 1:50

Datum: 18-04-2023

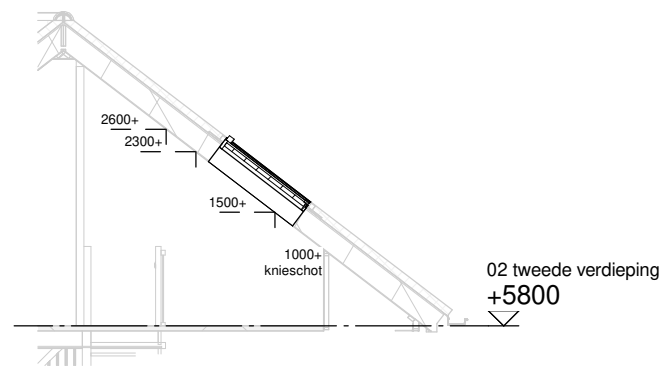
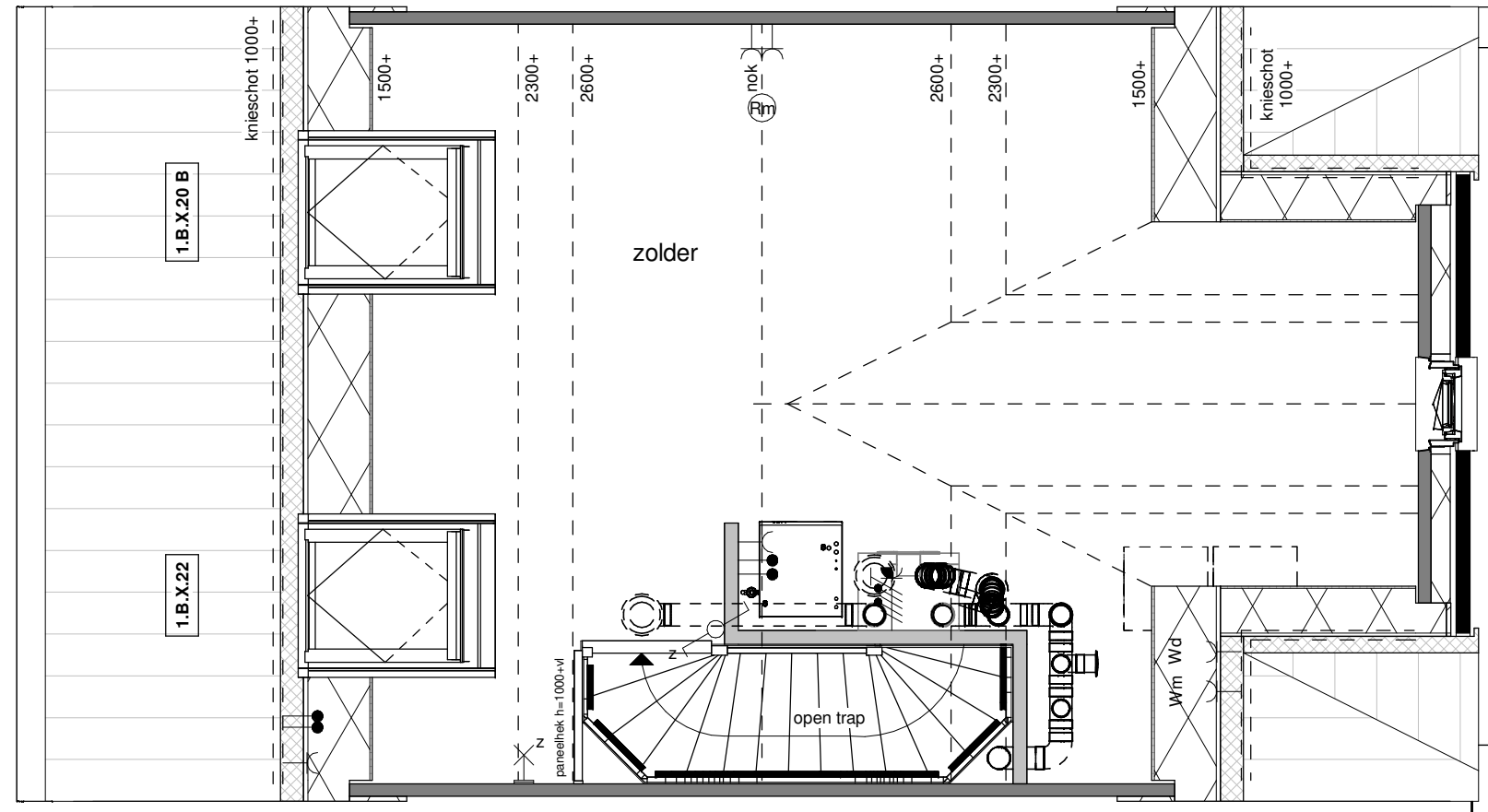

Doorsnede schaal 1:100



Achtergevel schaal 1:100

Optie: **Dakramen
achtergevel**

Woningtype: **C57-T**

Bouwnummer: -

Optienummer: **1.B.X.20 / 1.B.X.22**

Schaal: **1:50 / 1:100**

Datum: **18-04-2023**

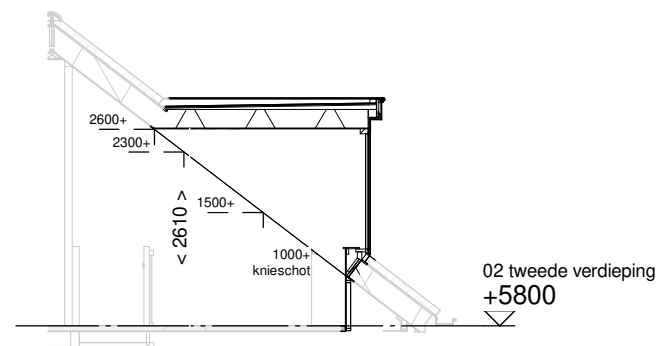
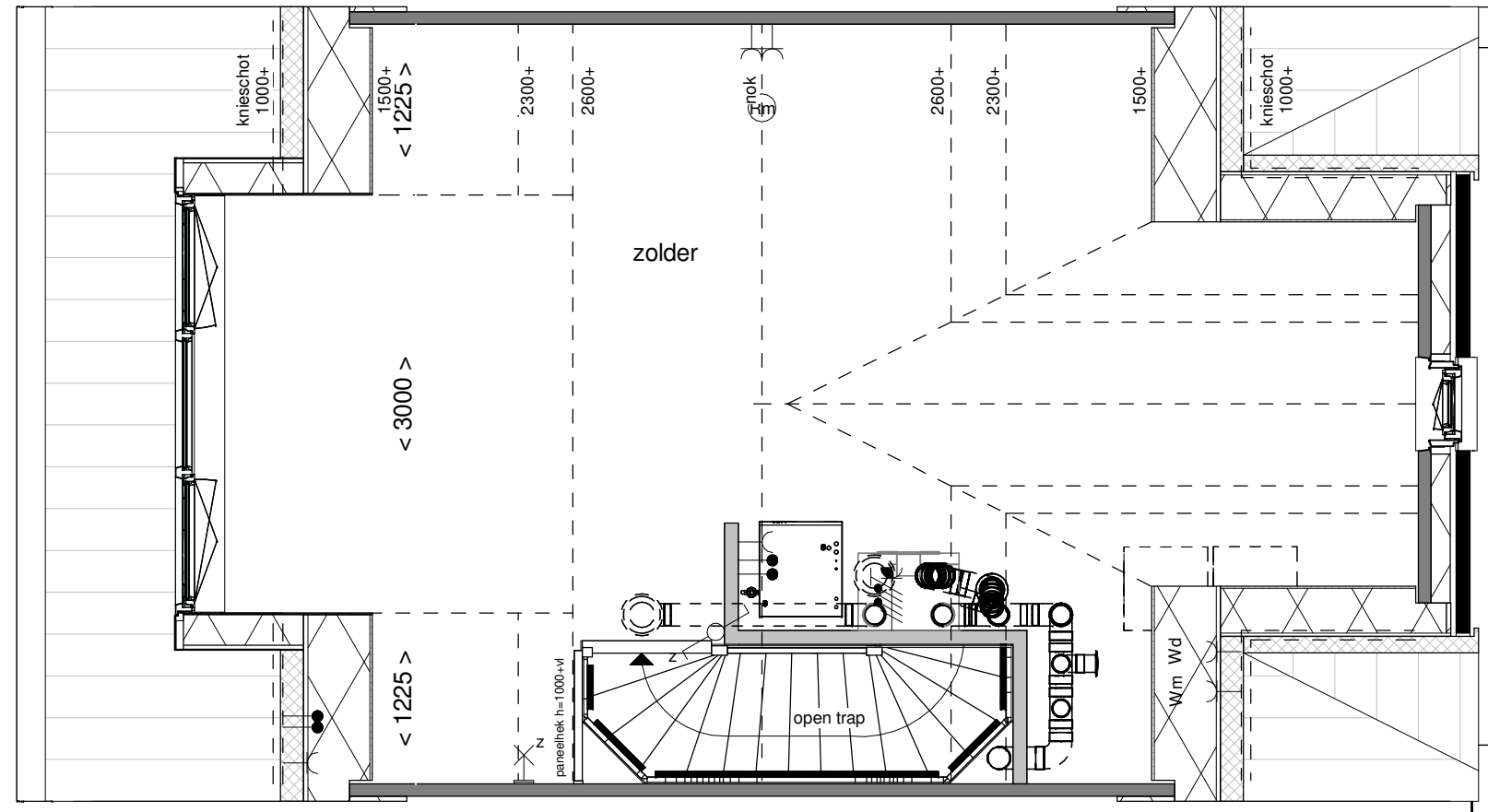

Achtergevel schaal 1:100



Achtergevel schaal 1:100

**BENT
WIJCK**
BENTHUIZEN

Optie: **Dakkapel
achtergevel 300cm**

Woningtype: **C57-T**

Bouwnummer: -

Optienummer: **1.B.X.34**

Schaal: **1:50 / 1:100**

Datum: **18-04-2023**