

Tekening:	Situatie
Woningtype:	-
Bouwnummer:	68-95, 140
Bladnummer:	VT-00-S02b
Schaal:	1:500
Datum:	04-04-2023

# Renvooi

- entree woning
- erfgrans
- P1 parkeervak eigen terrein
- buitenunit warmtepomp
- leiding buitenunit
- mantelbuis t.b.v. nuts
- haag H=600mm
- haag H=1800mm
- schutting H=1800mm
- schutting H=2100mm
- gaashek met klimplanten H=1800mm
- plantenrol
- stalen poort
- mandelig terrein
- speeltuin
- transformatorhuis
- opstelplaats vuilcontainer
- ondergronds containers
- hellingbaan
- talud
- lage houten beschoeiing

## parkeerplekken en posities bomen indicatief





BENT  
WIJCK  
BENTHUIZEN

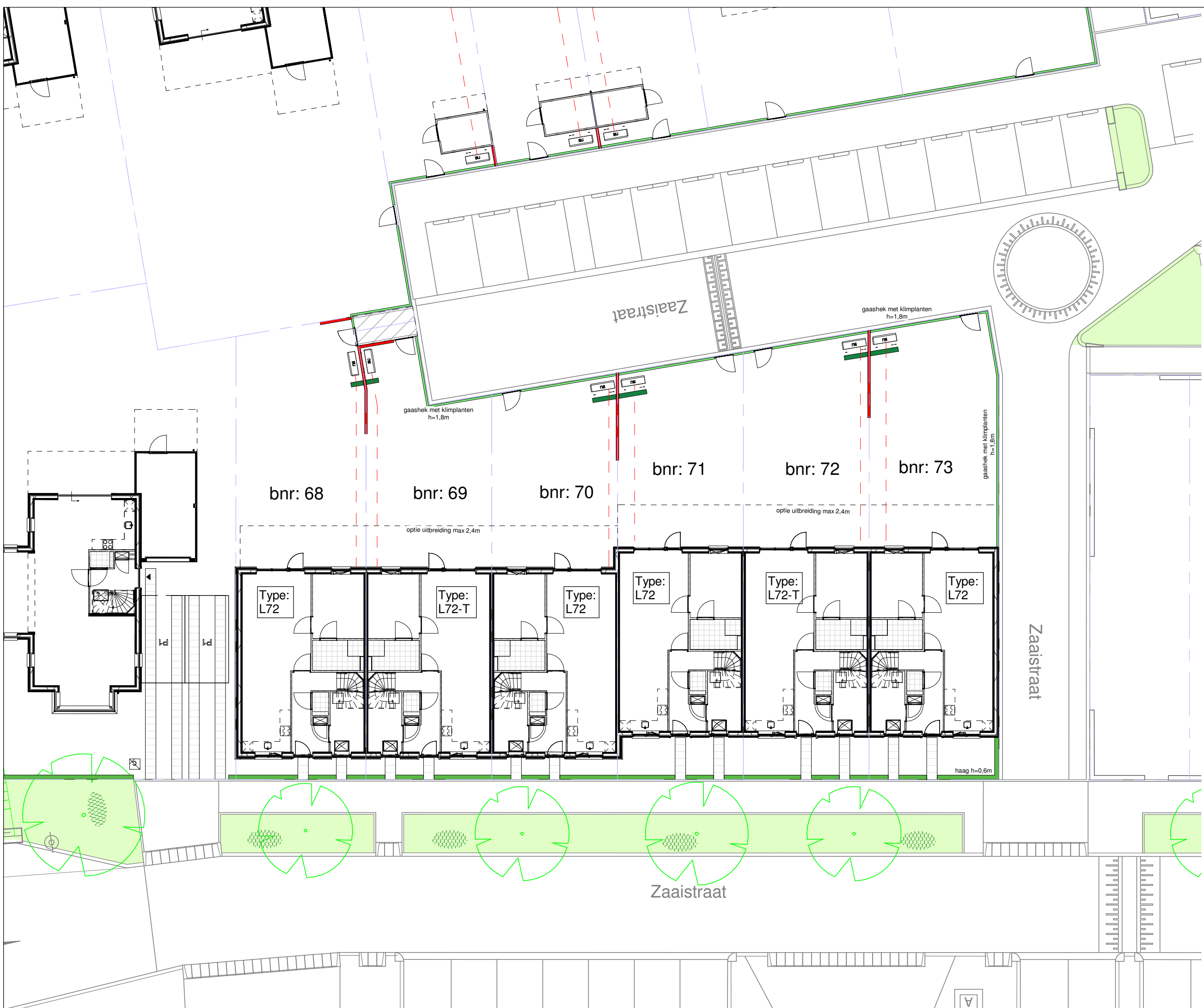









Tekening: Situatie Blok 16  
Woningtype: L72, L72-T  
Bouwnummer: 68 t/m 73  
Bladnummer: VT-16-S01  
Schaal: 1:200  
Datum: 18-04-2023

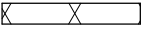

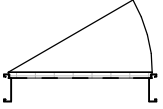
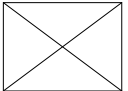
## Renvooi materialen

	dakpan donkergrijs
	dakpan grijs
	dakpan rood
	metselwerk kleur rood
	metselwerk kleur bruin
	metselwerk kleur geel
	metselwerk kleur wit
	metselwerk kleur oranje
	metselwerk kleur roodbruin
	metselwerk kleur grijs
	Gevelbetimmering vezelcement, lood
	Gevelbetimmering vezelcement, roomwit

## Renvooi bouwkundig

	entree woning
	metselwerk
	isolatie
	dragende wand
	niet dragende binnenwand
	binnendeurkozijn (met bovenlicht)
	kruipluik
	opstelplaats wasmachine
	opstelplaats wasdroger
	opstelplaats koelkast
	principe opstelling keukenblok (elektra conform nultekeningen Bruynzeel)
	
	onbenoemde ruimte volgens krijtstreepmethode

## Renvooi installaties

	aansluitpunt licht, wand
	centraaldoos met lichtpunt
	armatuur aan de wand
	rookmelder
	aansluitpunt niet bedraad / loos
	beldrukker
	schel
	schakelaar, 1-polig
	werkschakelaar tbv PV-panelen
	driestandenschakelaar tbv wtw
	schakelaar, wissel
	schakelaar, serie
	pulsschakelaar tbv warmteterugwinunit
	wandcontactdoos 1-voudig met beschermingscontact
	wandcontactdoos 2-voudig met beschermingscontact
	thermostaatleiding, bedraad
	wandcontactdoos tbv warmteterugwinunit
	wtw mechanische ventilatie-unit incl. warmteterugwinunit
	wp warmtepomp
	inblaasventiel mechanische ventilatie
	afzuigventiel mechanische ventilatie
	wv verdeler vloerverwarming
	ruimte vzv vloerverwarming
	rad elektrische radiator
	kanalen in het zicht
	doucheput
	lijngoot douche

### Disclaimer

De op deze tekeningen aangegeven maten zijn circa maten in millimeters en tussen de wanden / vloeren gemeten, waarbij geen rekening is gehouden met enige wandafwerking, plinten, aftimmering, etc. In verband met de nauwkeurige uitwerking van details, constructie, maatvoering, materialen e.d. kunnen er kleine afwijkingen ontstaan ten opzichte van de nu vermelde gegevens. Deze geringe afwijkingen geven geen aanleiding tot verrekening. Aan de op deze tekening aangegeven maten kunnen derhalve geen rechten worden ontleend. De op deze tekeningen aangegeven maatvoering is niet geschikt voor opdrachten aan derden door koper(s). De posities van aansluitingen en installatie onderdelen zijn indicatief op tekening aangegeven. De exacte aantallen en posities zullen na berekening in het werk door de installateurs worden bepaald en kunnen afwijken van deze tekening.



Tekening: Renvooi

Woningtype: -

Bouwnummer:

Bladnummer: VT-0-00c

Schaal:

Datum: 04-04-2023



Type: L72  
Bouwnummer: 68

Type: L72t  
Bouwnummer: 69

Type: L72  
Bouwnummer: 70

Type: L72  
Bouwnummer: 71

Type: L72t  
Bouwnummer: 72

Type: L72  
Bouwnummer: 73



Type: L72  
Bouwnummer: 73

Type: L72t  
Bouwnummer: 72

Type: L72  
Bouwnummer: 71

Type: L72  
Bouwnummer: 70

Type: L72t  
Bouwnummer: 69

Type: L72  
Bouwnummer: 68



Tekening: Gevels Blok 16

Woningtype: L72/L72t

Bouwnummer: 68 t/m 73

Bladnummer: VT-L16-00a

Schaal: 1:100

Datum: 18-04-2023

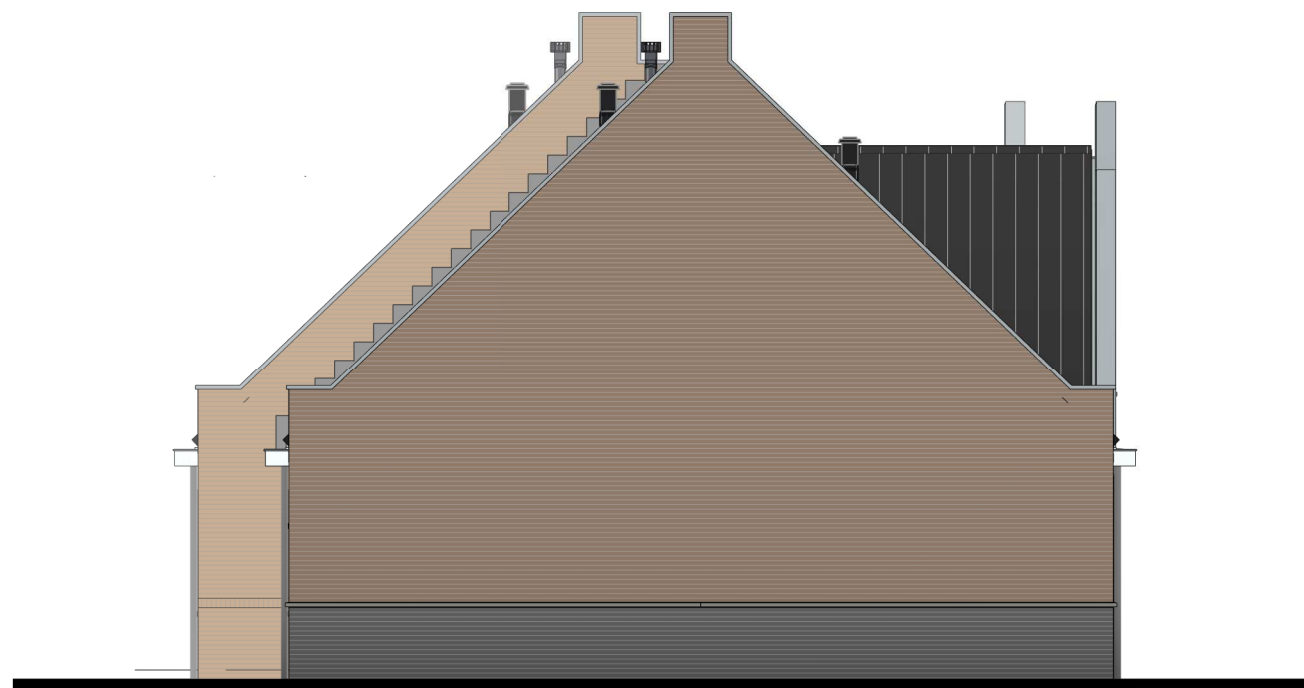

Type: L72  
Bouwnummer: 68

Linker zijgevel

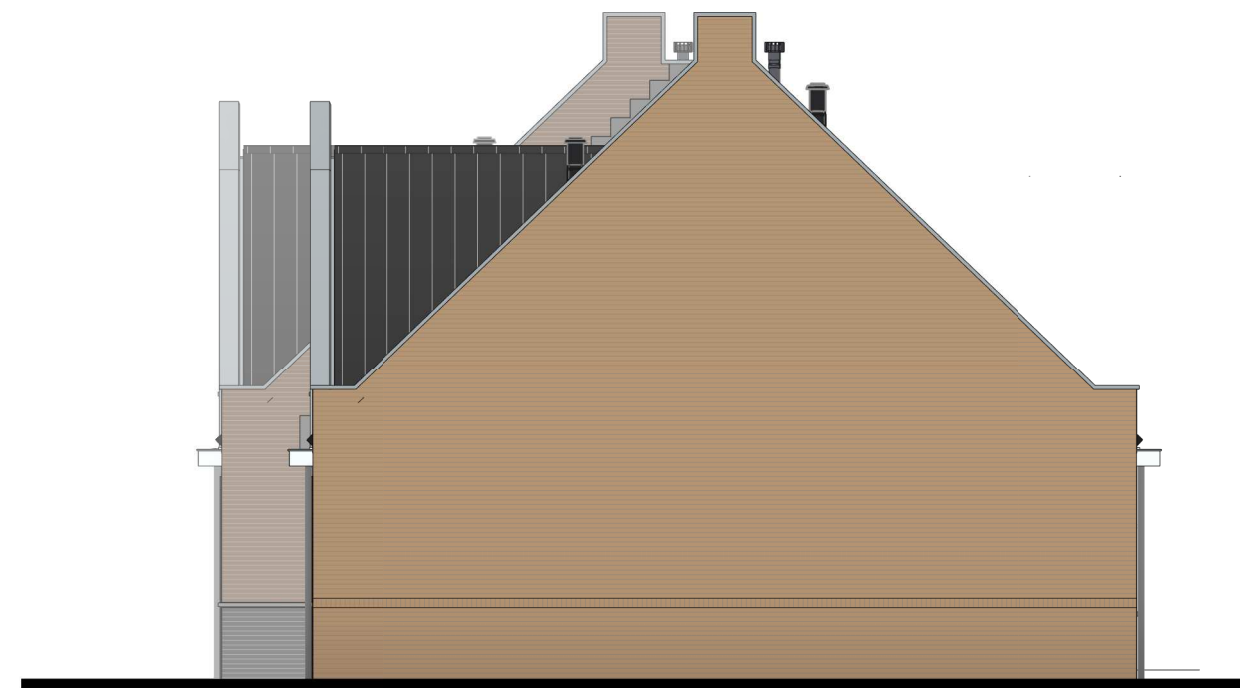

Type: L72  
Bouwnummer: 73

Rechter zijgevel



Tekening: Zijgevels Blok 16

Woningtype: L72/L72t

Bouwnummer: 68 t/m 73

Bladnummer: VT-L16-00b

Schaal: 1:100

Datum: 18-04-2023

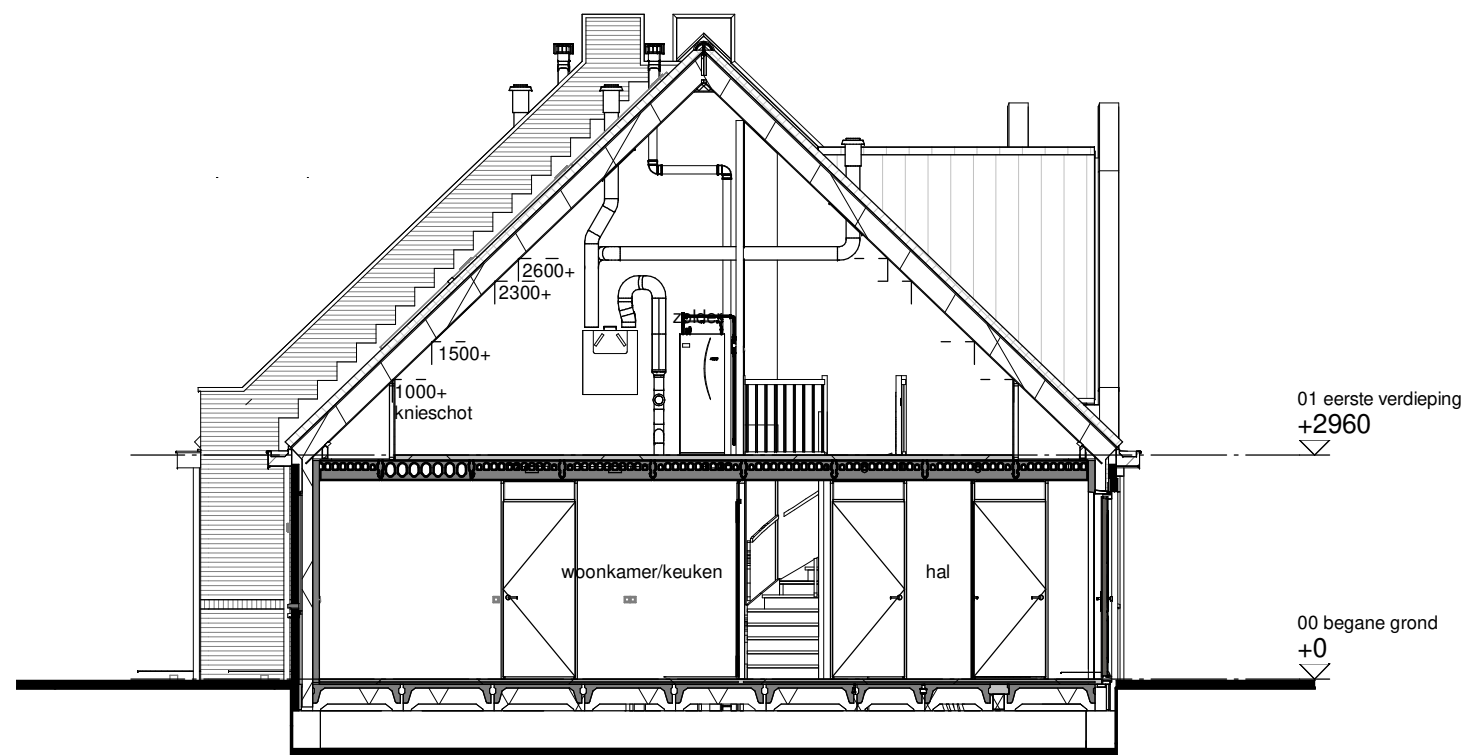

Type: L72  
Bouwnummer: 68

Doorsnede A

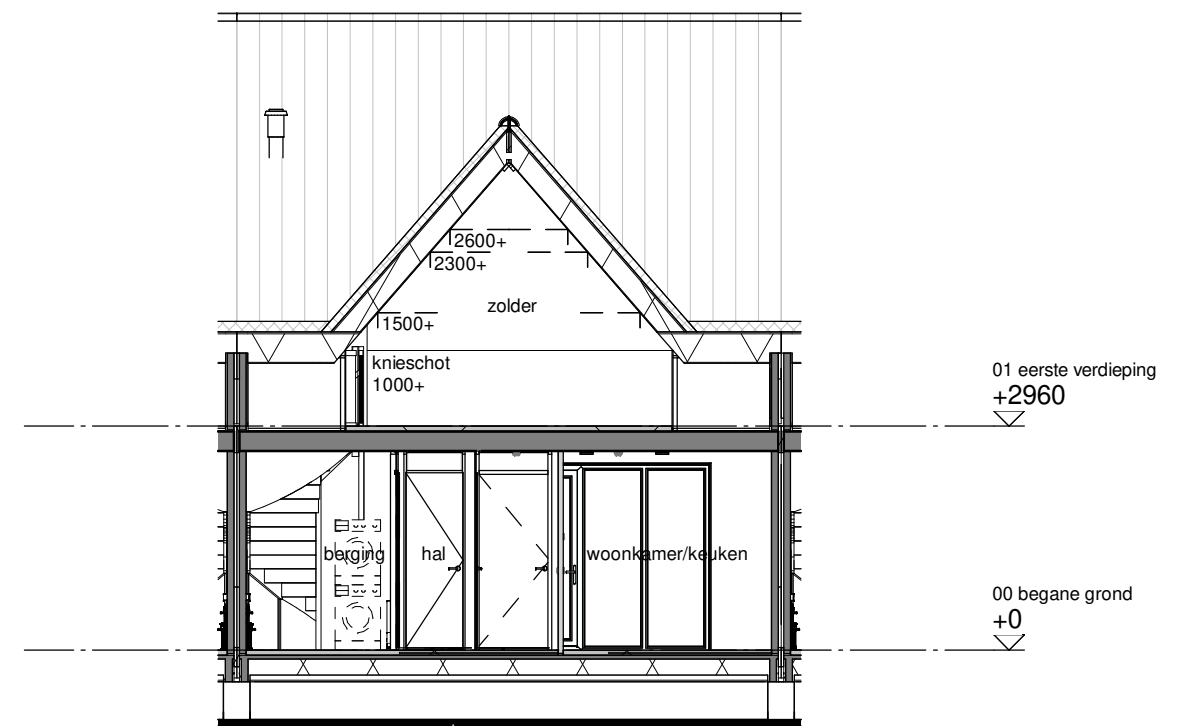

Type: L72t  
Bouwnummer: 69

Doorsnede B



Tekening: Doorsneden Blok 16  
 Woningtype: L72/L72t  
 Bouwnummer: 68 t/m 73  
 Bladnummer: VT-L16-00c  
 Schaal: 1:100  
 Datum: 18-04-2023

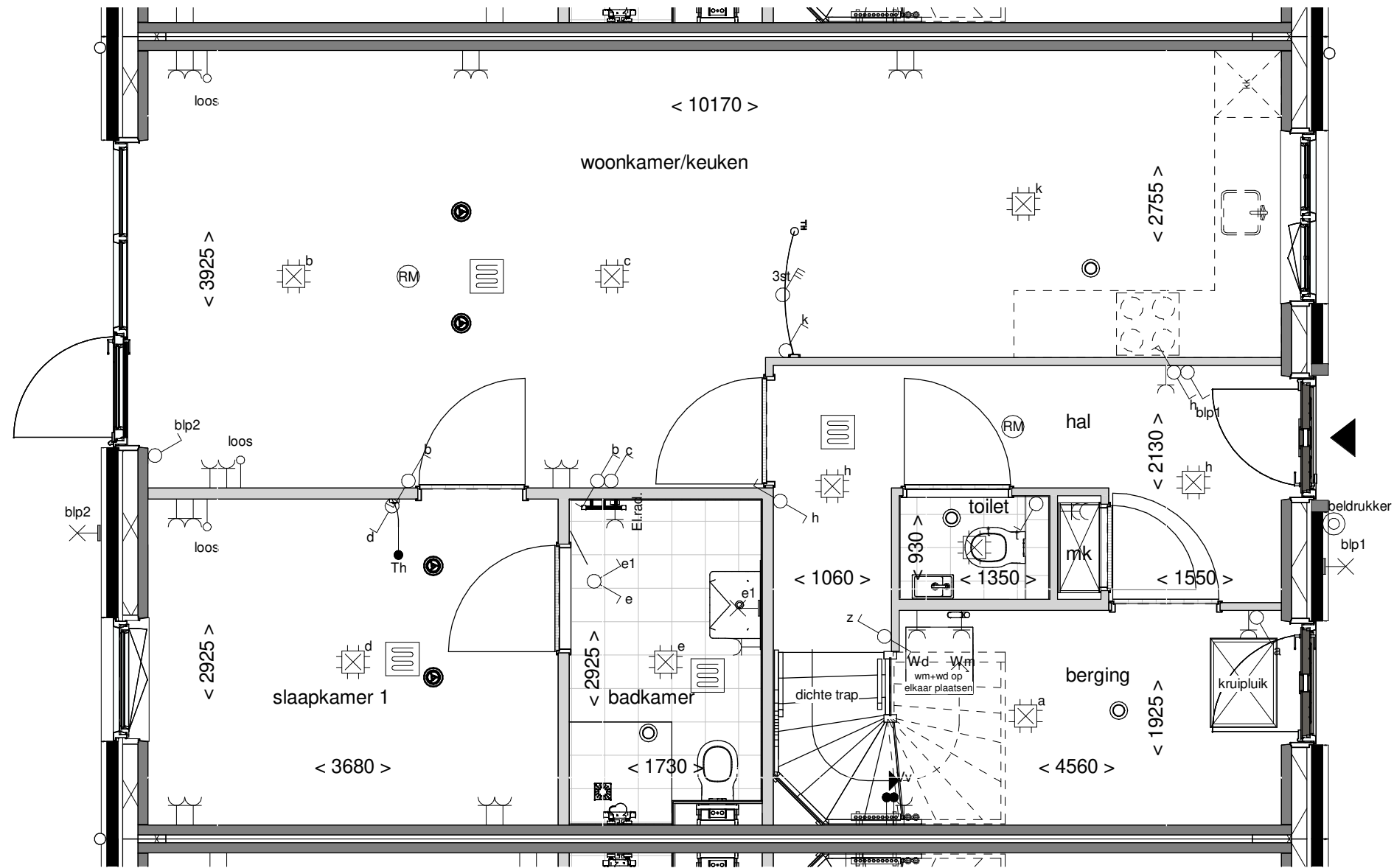

Tekening: Begane grond

Woningtype: L72t

Bouwnummer: 69

Bladnummer: VT-L-69a

Schaal: 1:50

Datum: 18-04-2023

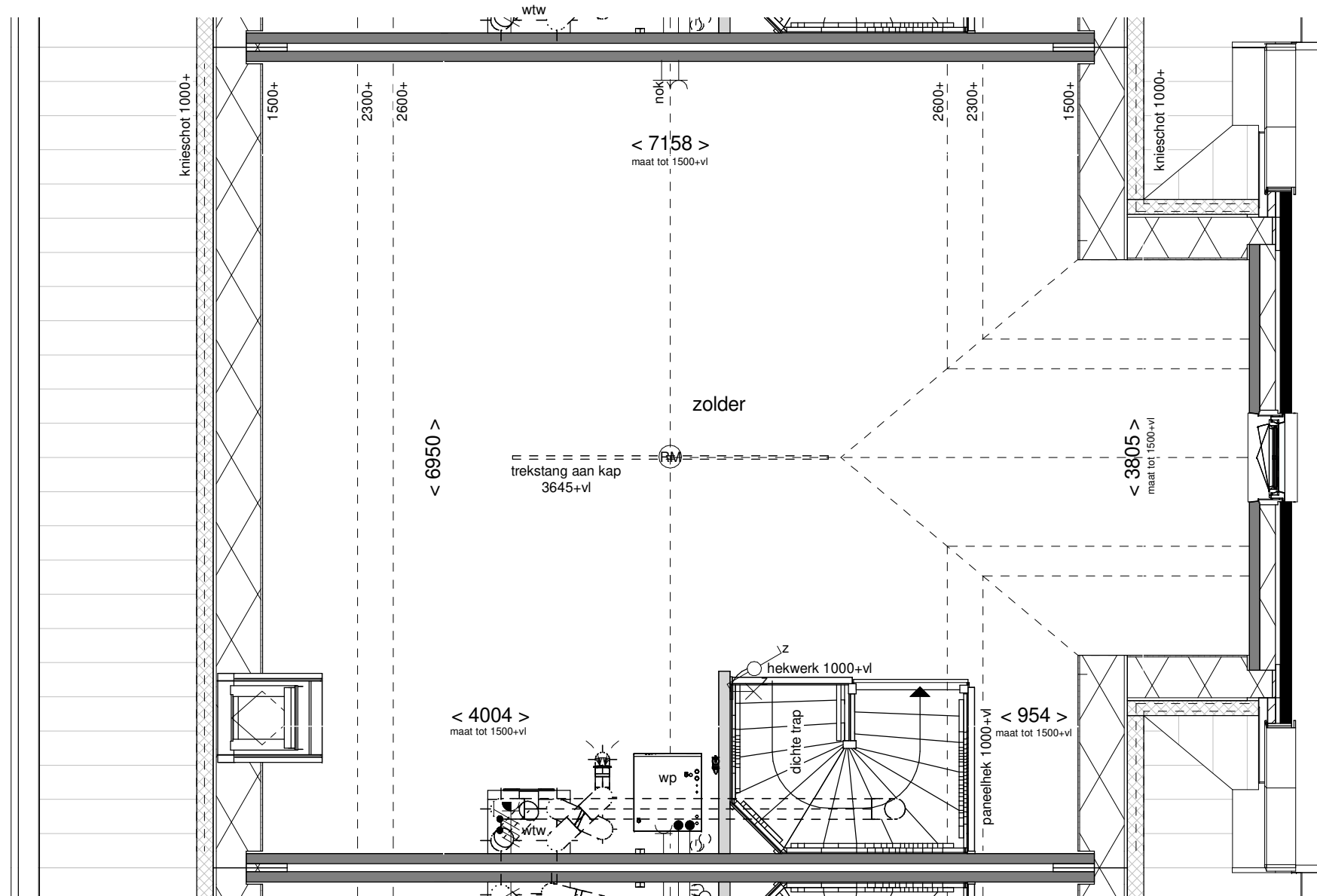

Tekening: Eerste verdieping

Woningtype: L72t

Bouwnummer: 69

Bladnummer: VT-L-69b

Schaal: 1:50

Datum: 18-04-2023



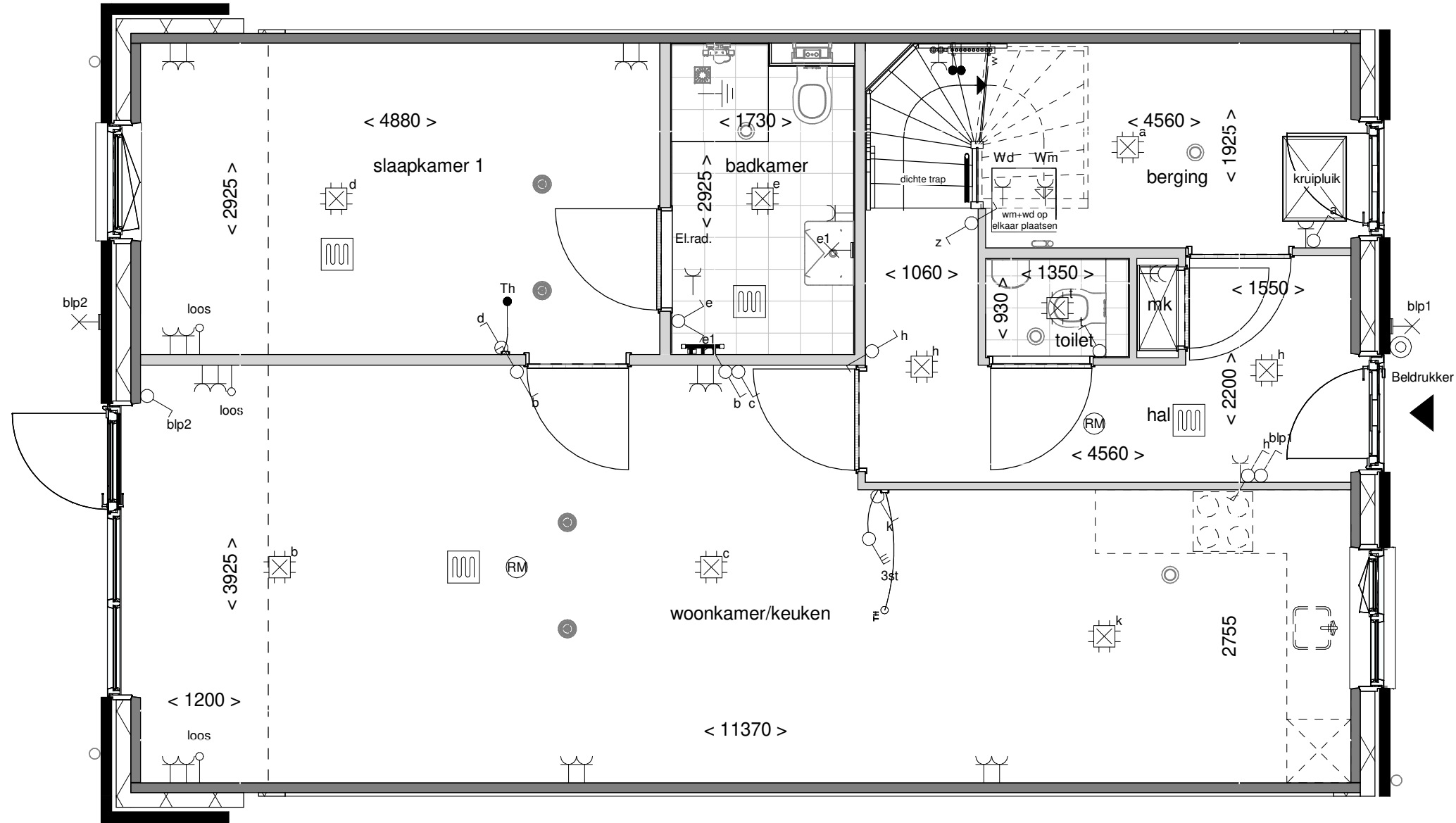

Achtergevel schaal 1:100



Optie: **Uitbouw achtergevel 120cm**

Woningtype: **L72**

Bouwnummer:

Optienummer: **1.A.X.19**

Schaal: **1:50 / 1:100**

Datum: **18-04-2023**

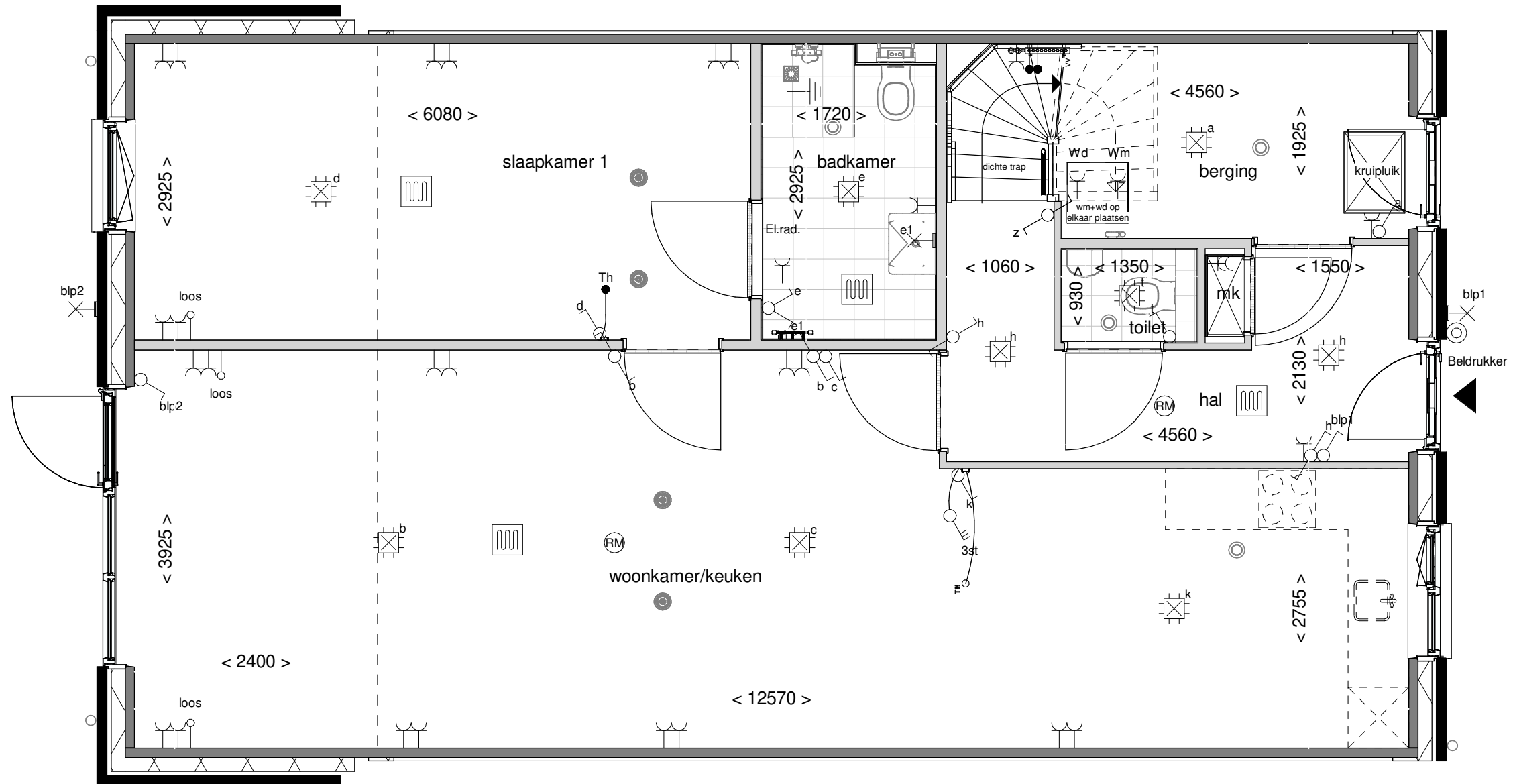

Achtergevel schaal 1:100

**BENT  
WIJCK**  
BENTHUIZEN

Optie: **Uitbouw achtergevel  
240cm**

Woningtype: **L72**

Bouwnummer:

Optienummer: **1.A.X.39**

Schaal: **1:50 / 1:100**

Datum: **18-04-2023**

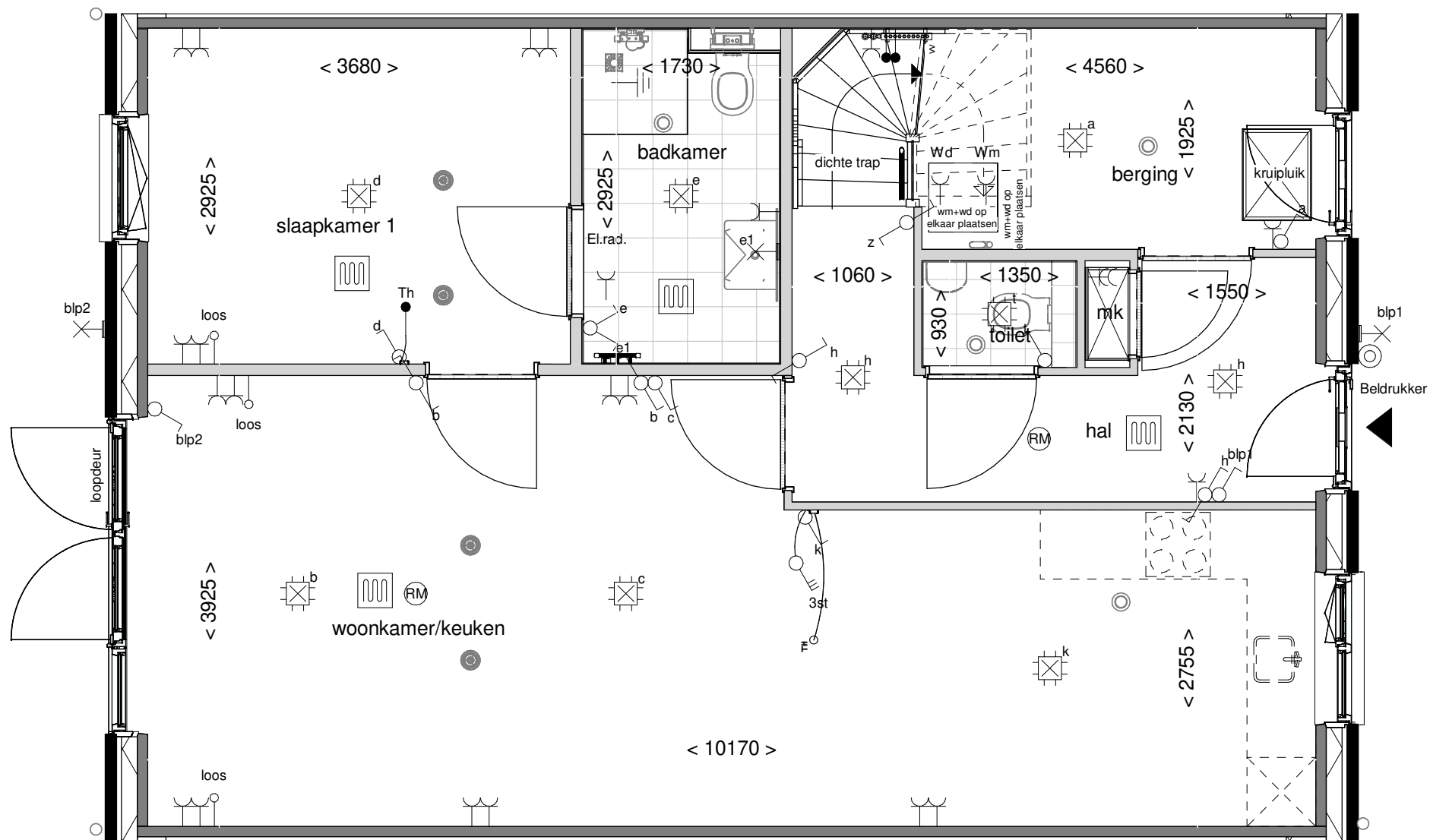

Achtergevel schaal 1:100

**BENT  
WIJCK**  
BENTHUIZEN

Optie: dubbele deuren  
achtergevel

Woningtype: L72

Bouwnummer:

Optienummer: 1.A.X.58

Schaal: 1:50 / 1:100

Datum: 18-04-2023

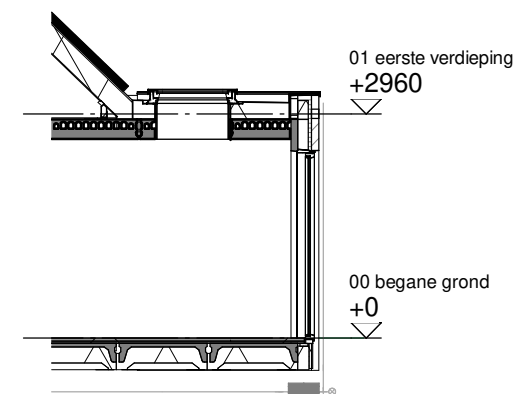
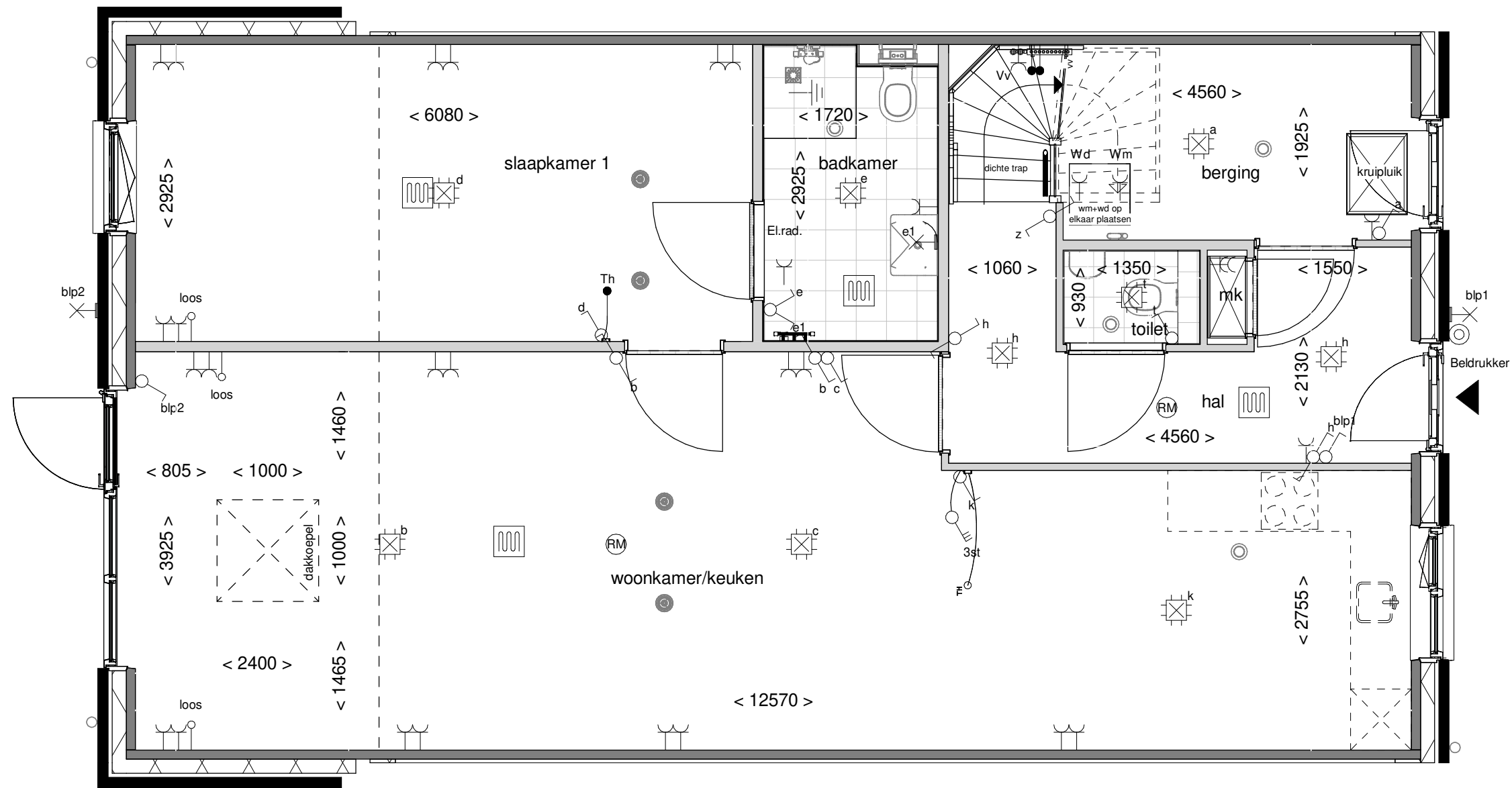

Doorsnede schaal 1:100

Optie: Lichtkoepel in uitbouw 240cm

Woningtype: L72

Bouwnummer: \_\_\_\_\_

Optienummer: 1.B.X.10

Schaal: 1:50 / 1:100

Datum: 18-04-2023

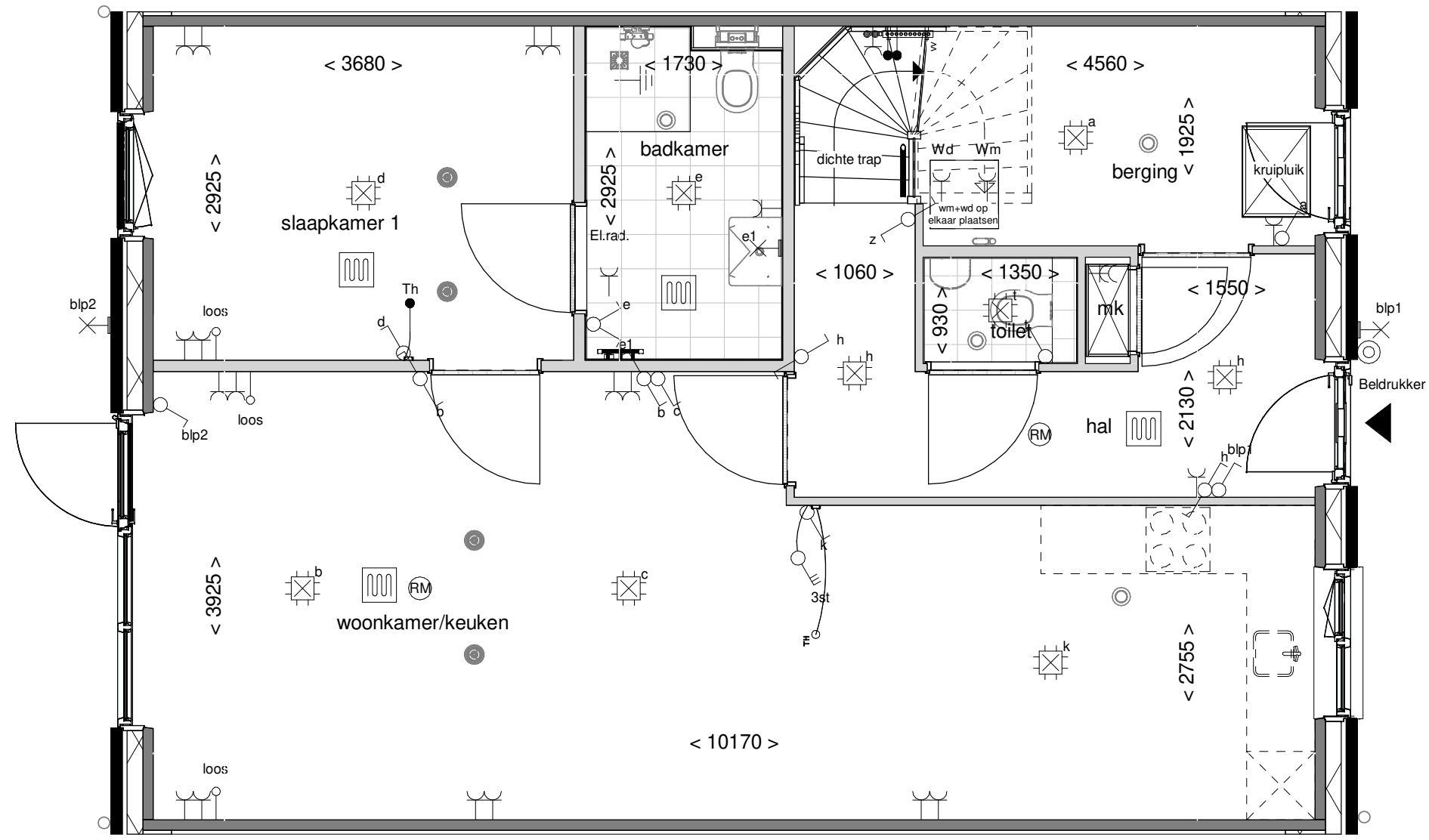

Achtergevel schaal 1:100



Optie: **Laag kozijn achtergevel**

---

Woningtype: **L72**

---

Bouwnummer:

---

Optienummer: **1.C.L.76**

---

Schaal: **1:50 / 1:100**

---

Datum: **18-04-2023**

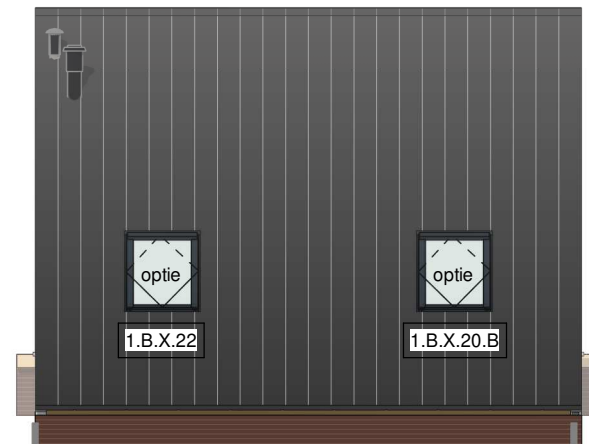
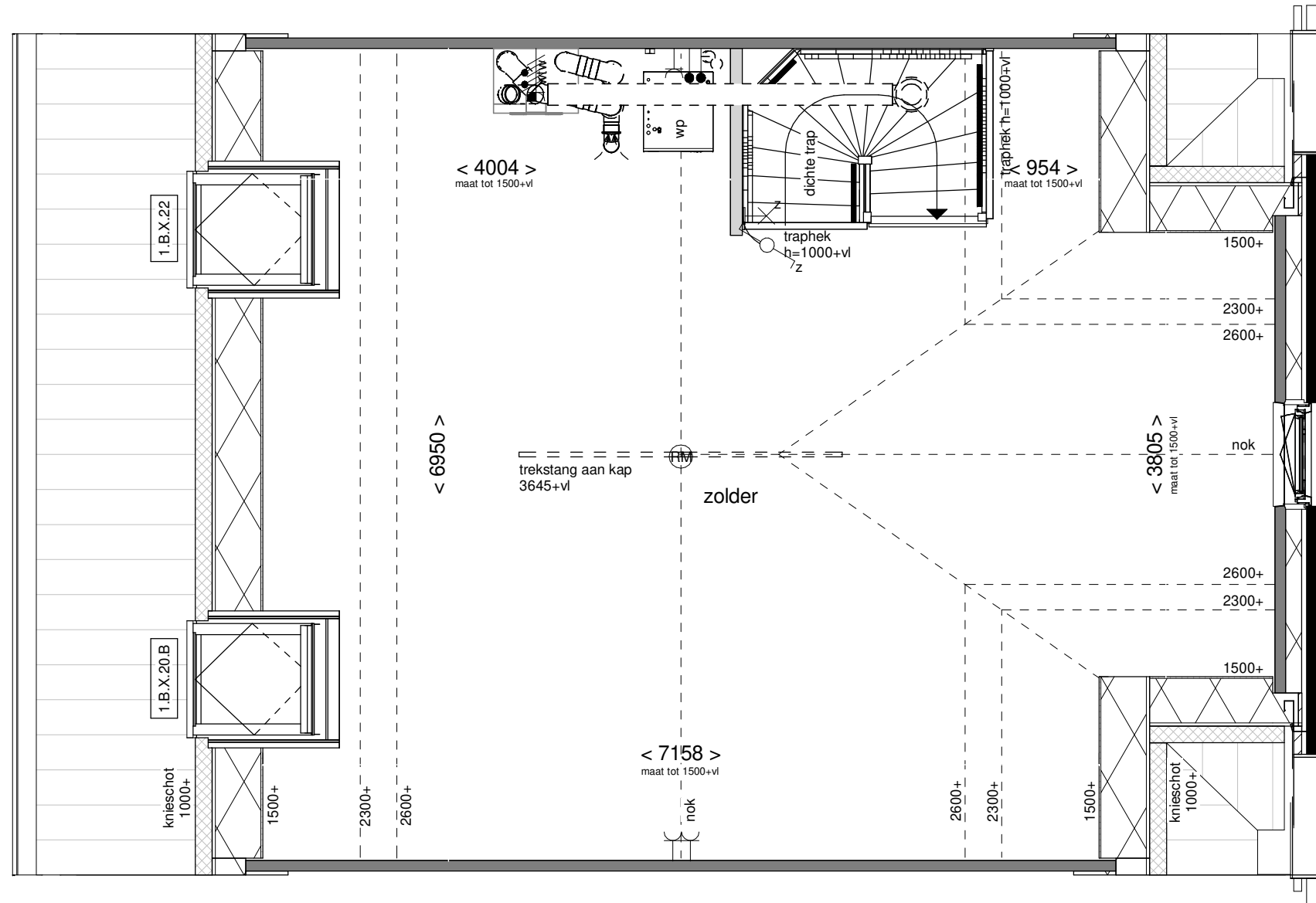

Achtergevel schaal 1:100

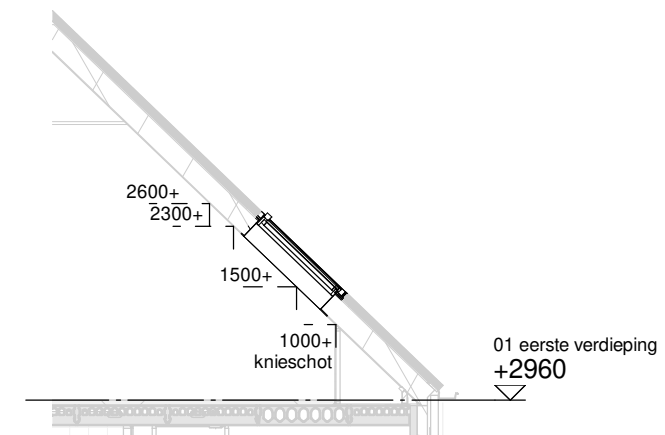

Doorsnede schaal 1:100



Optie: Dakramen achtergevel

Woningtype: L72T

Bouwnummer:

Optienummer: 1.B.X.20 / 1.B.X.22

Schaal: 1:50 / 1:100

Datum: 18-04-2023

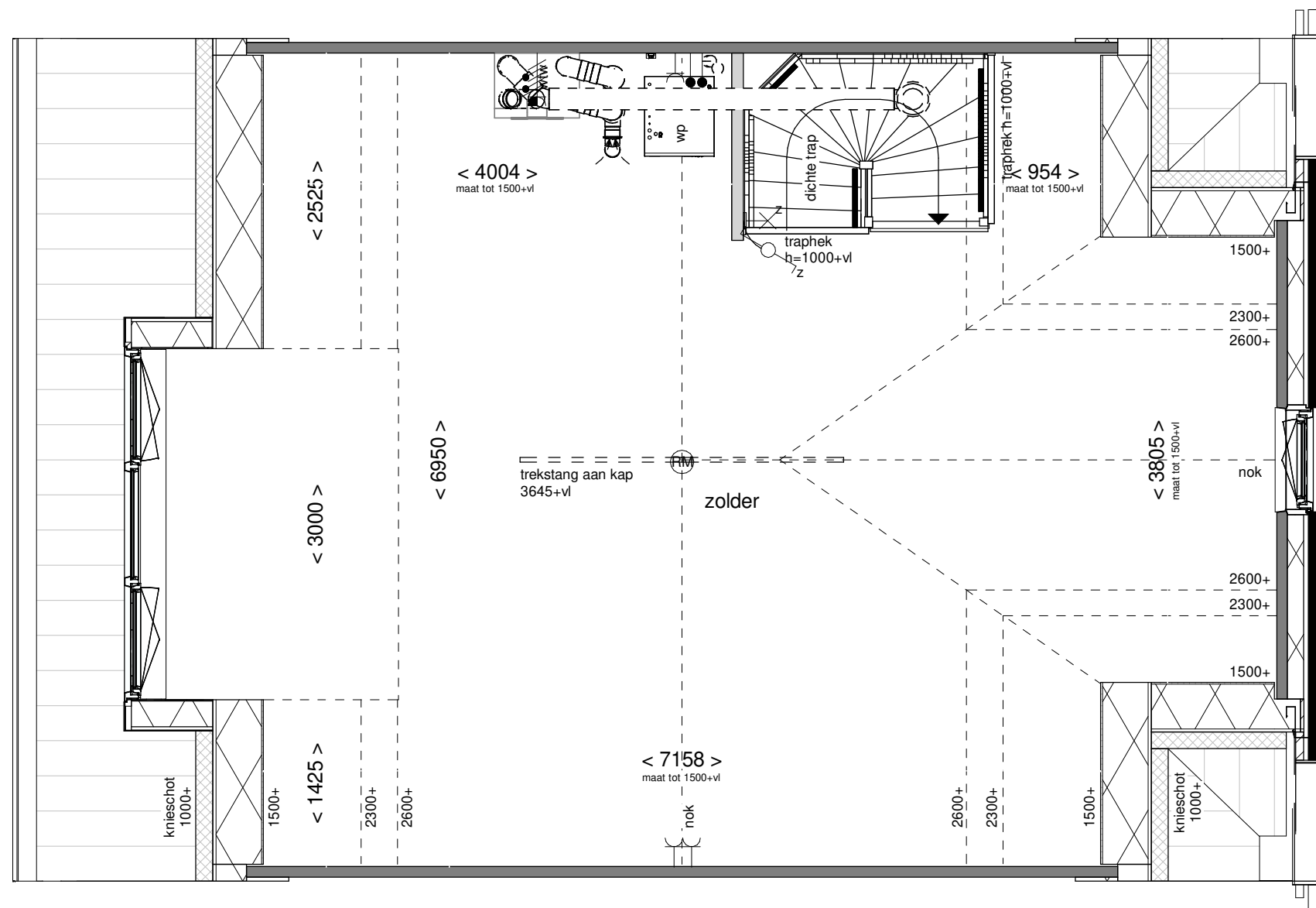

Achtergevel schaal 1:100

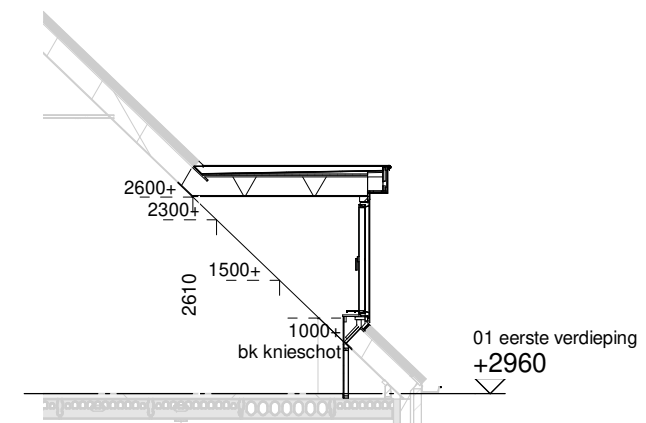

Doorsnede schaal 1:100

**BENT  
WIJCK**  
BENTHUIZEN

Optie: **Dakkapel  
achtergevel**

Woningtype: **L72T**

Bouwnummer:

Optienummer: **1.B.X.34A**

Schaal: **1:50 / 1:100**

Datum: **18-04-2023**

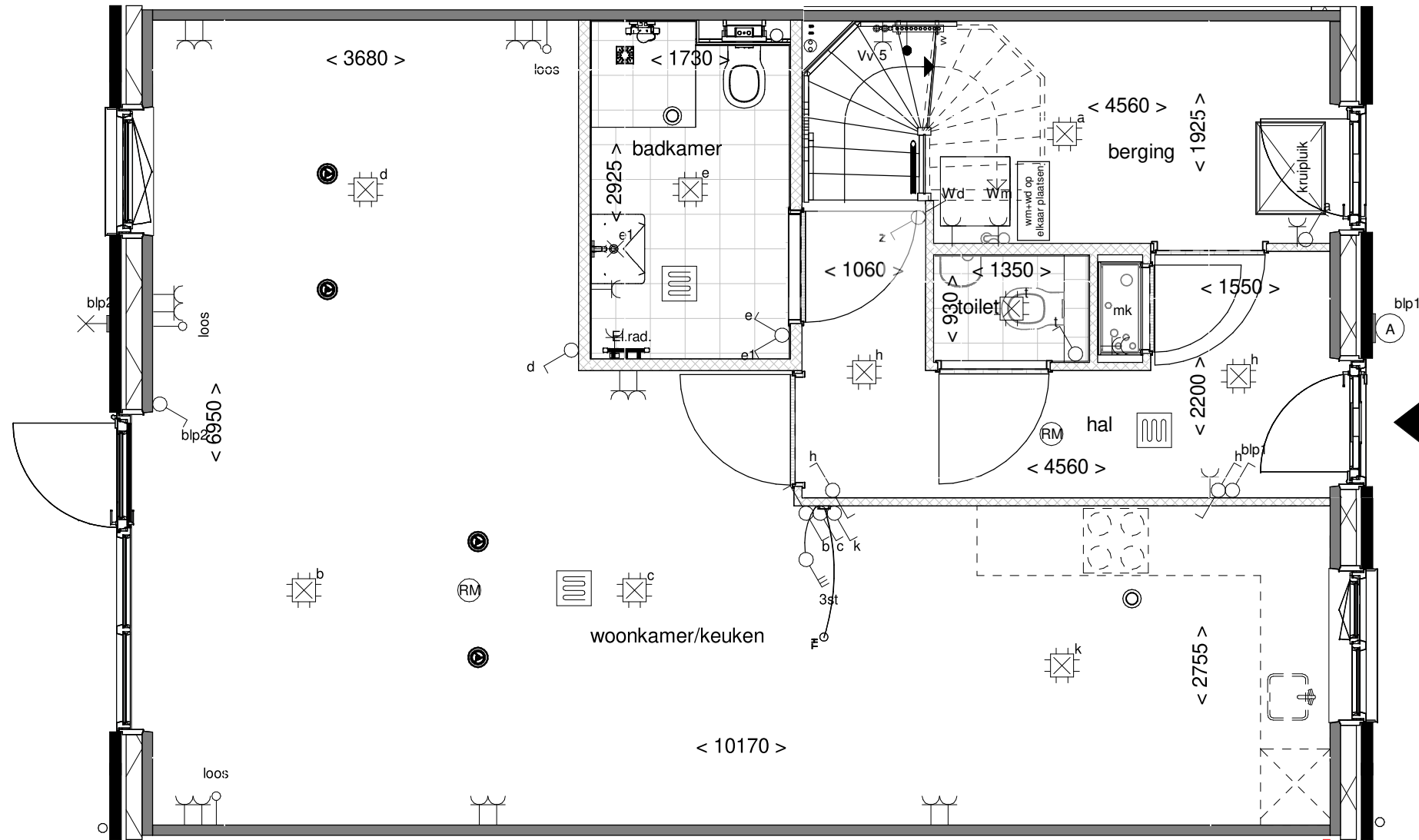

Optie: **Slpk bij woonkamer  
betrekken variant 1**

Woningtype: **L72**

Bouwnummer:

Optienummer: **1.C.L.10**

Schaal: **1:50**

Datum: **18-04-2023**



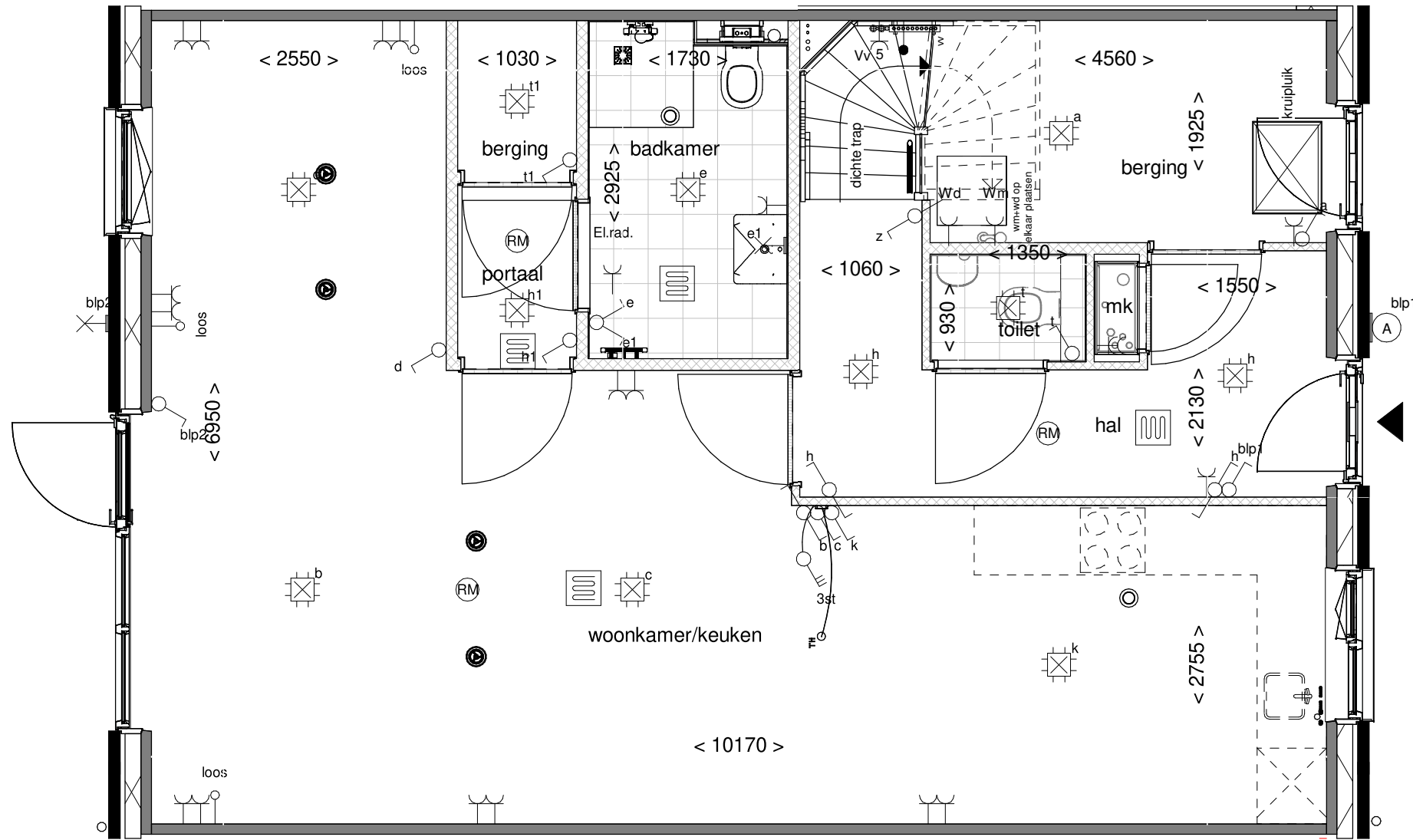

Optie: Slpk bij woonkamer  
betrekken variant 2

Woningtype: L72

Bouwnummer:

Optienummer: 1.C.L.12

Schaal: 1:50

Datum: 18-04-2023

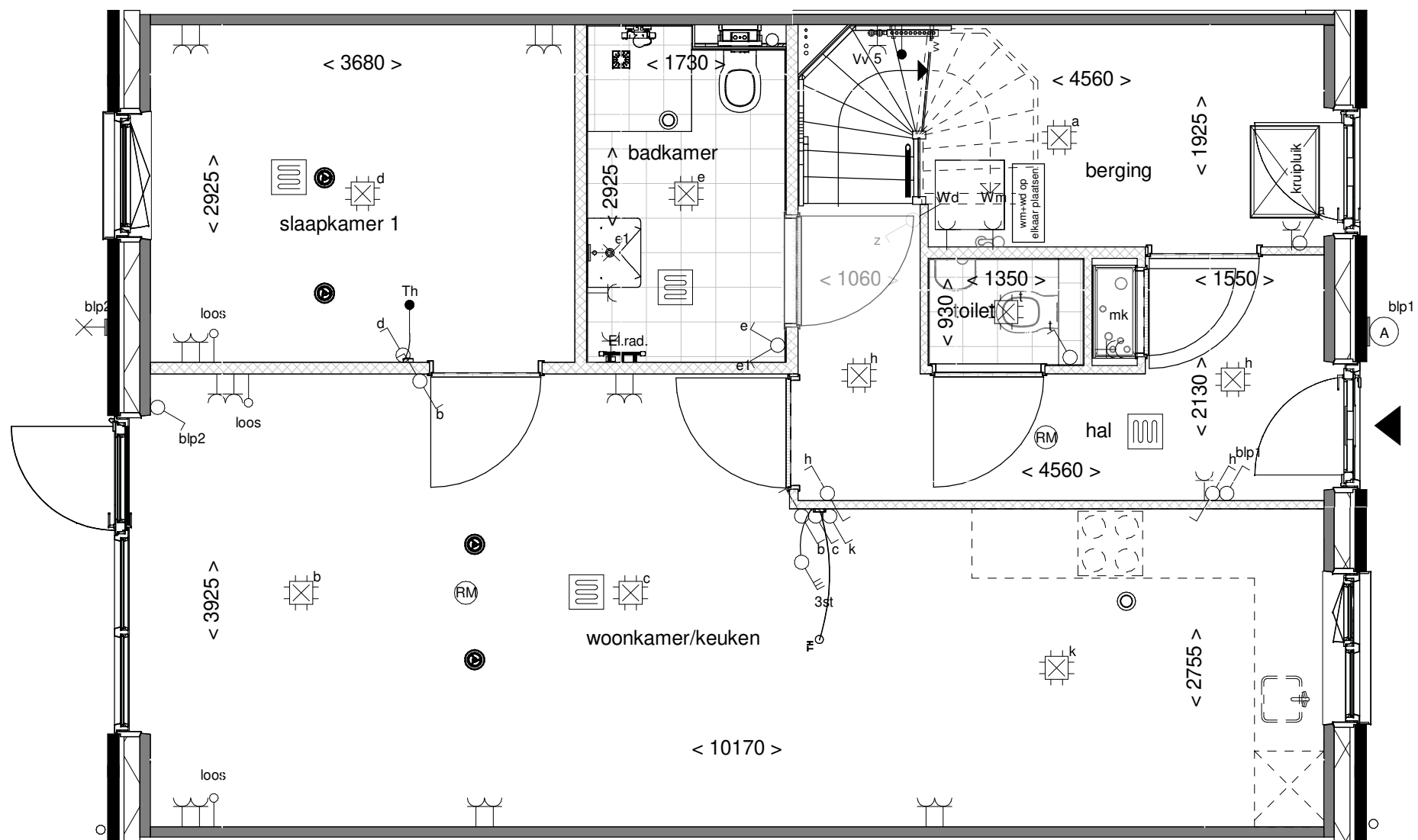

Optie: Badkamerdeur verplaatsen hal

Woningtype: L72

Bouwnummer: \_\_\_\_\_

Optienummer: 1.C.L.14

Schaal: 1:50

Datum: 18-04-2023

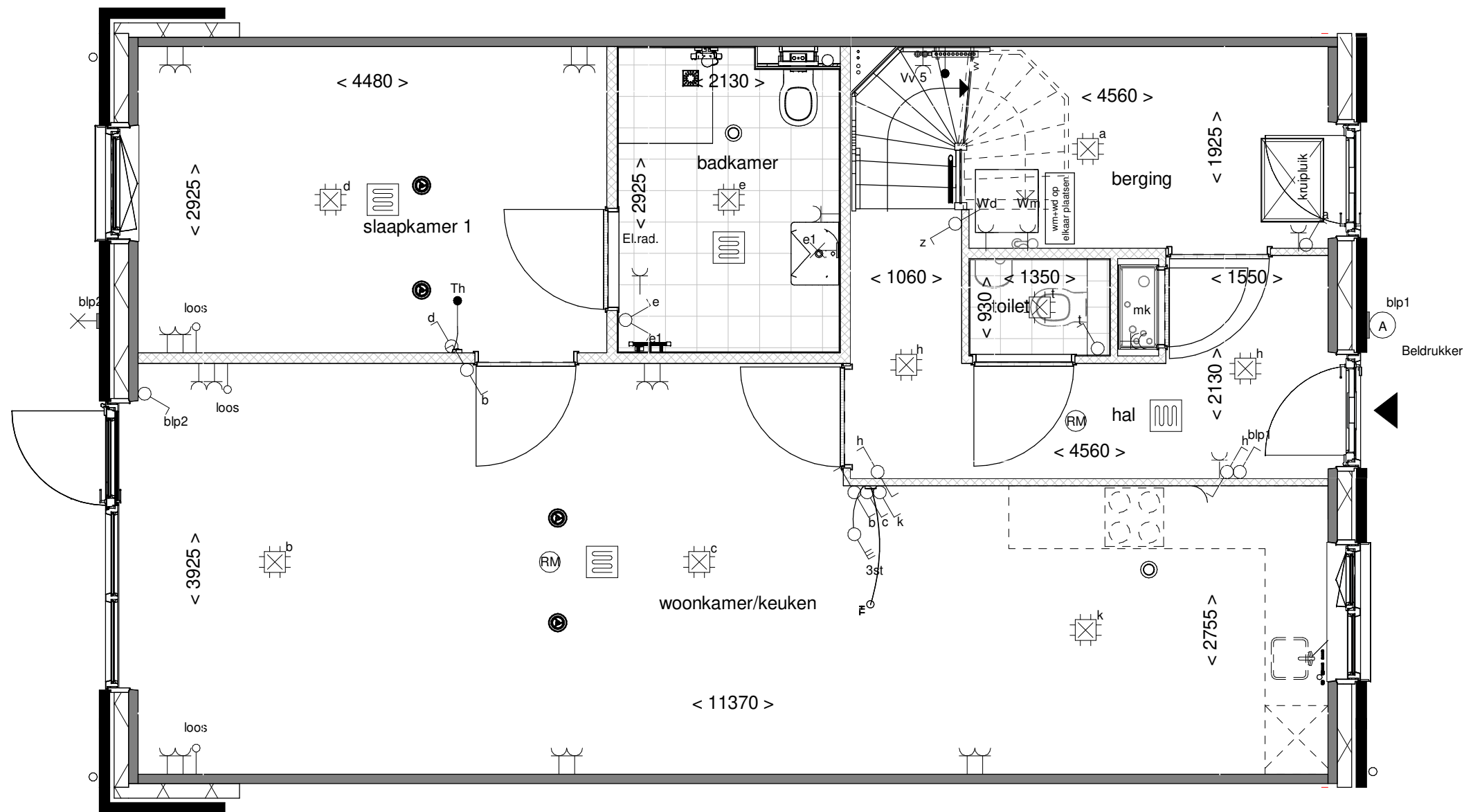

Optie: **Badk. vergroten  
i.c.m. 1.A.X.19**

Woningtype: **L72**

Bouwnummer:

Optienummer: **1.C.L.16 + 1.C.L.19**

Schaal: **1:50**

Datum: **18-04-2023**

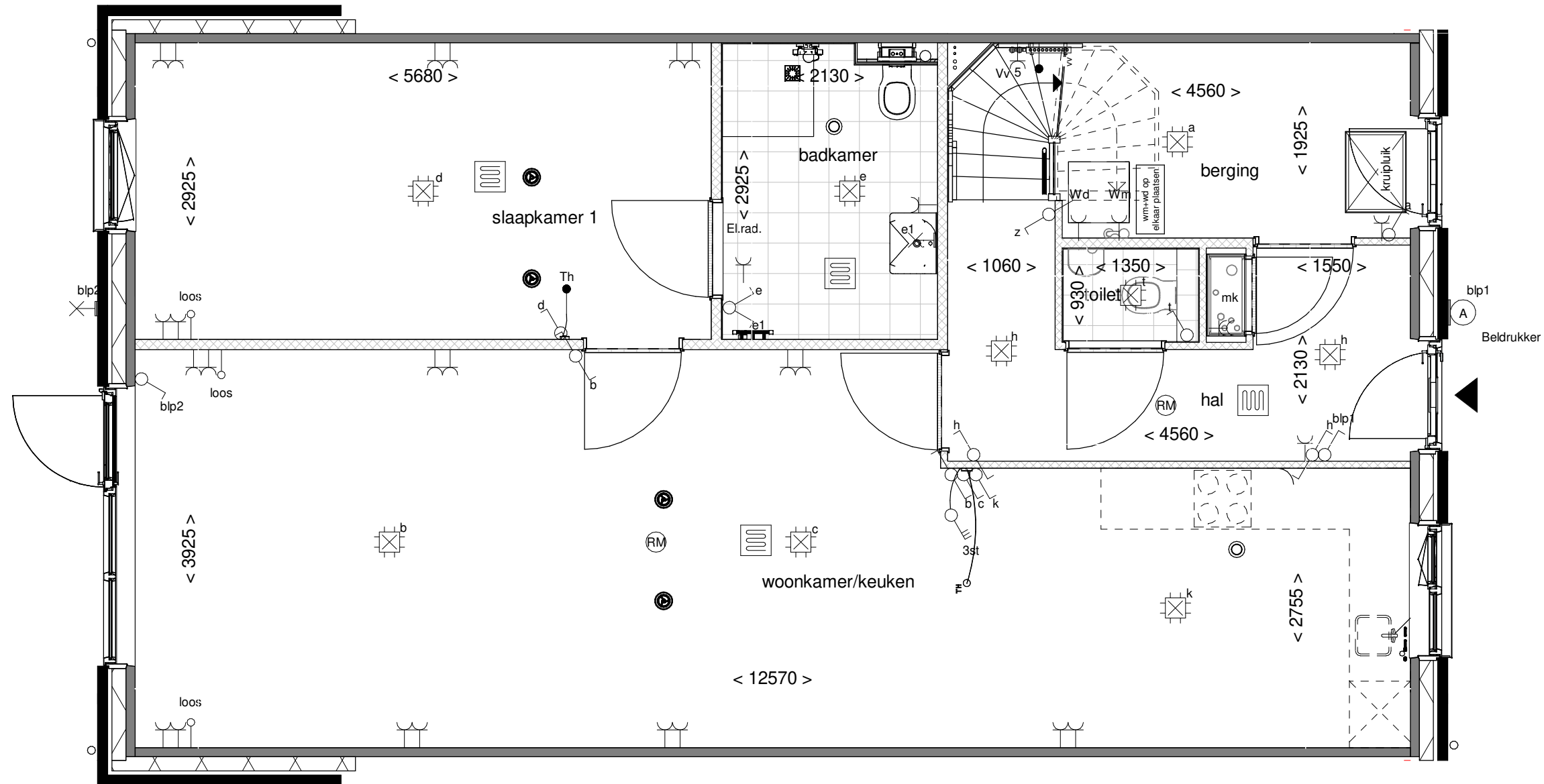

Optie: **Badk. vergroten  
i.c.m. 1.A.X.39**

---

Woningtype: **L72**

---

Bouwnummer:

---

Optienummer: **1.C.L.16 + 1.C.L.39**

---

Schaal: **1:50**

---

Datum: **18-04-2023**

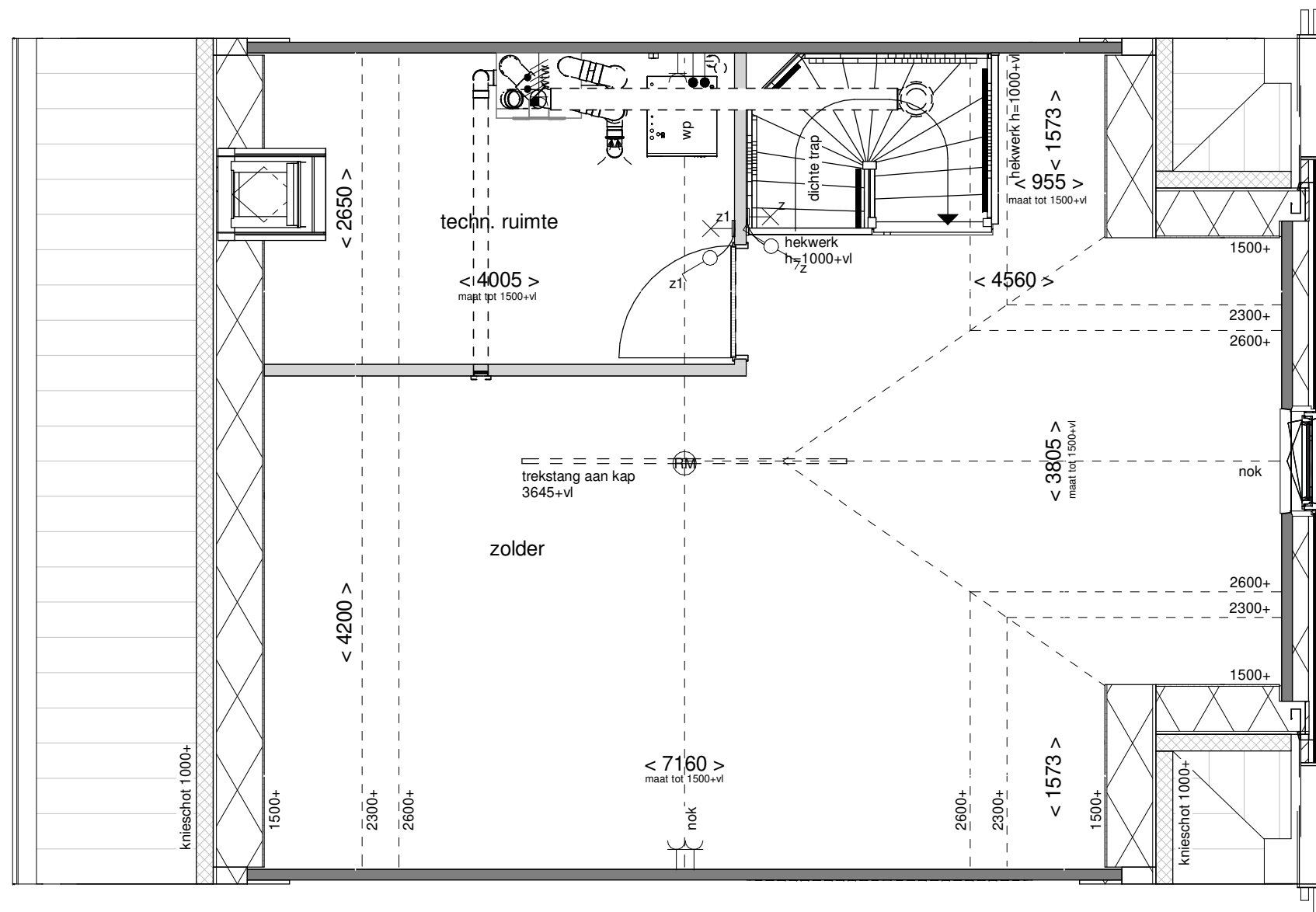

Optie: Indeling met techniekruimte

Woningtype: L72T

Bouwnummer: \_\_\_\_\_

Optienummer: 1.C.L.70

Schaal: 1:50

Datum: 18-04-2023

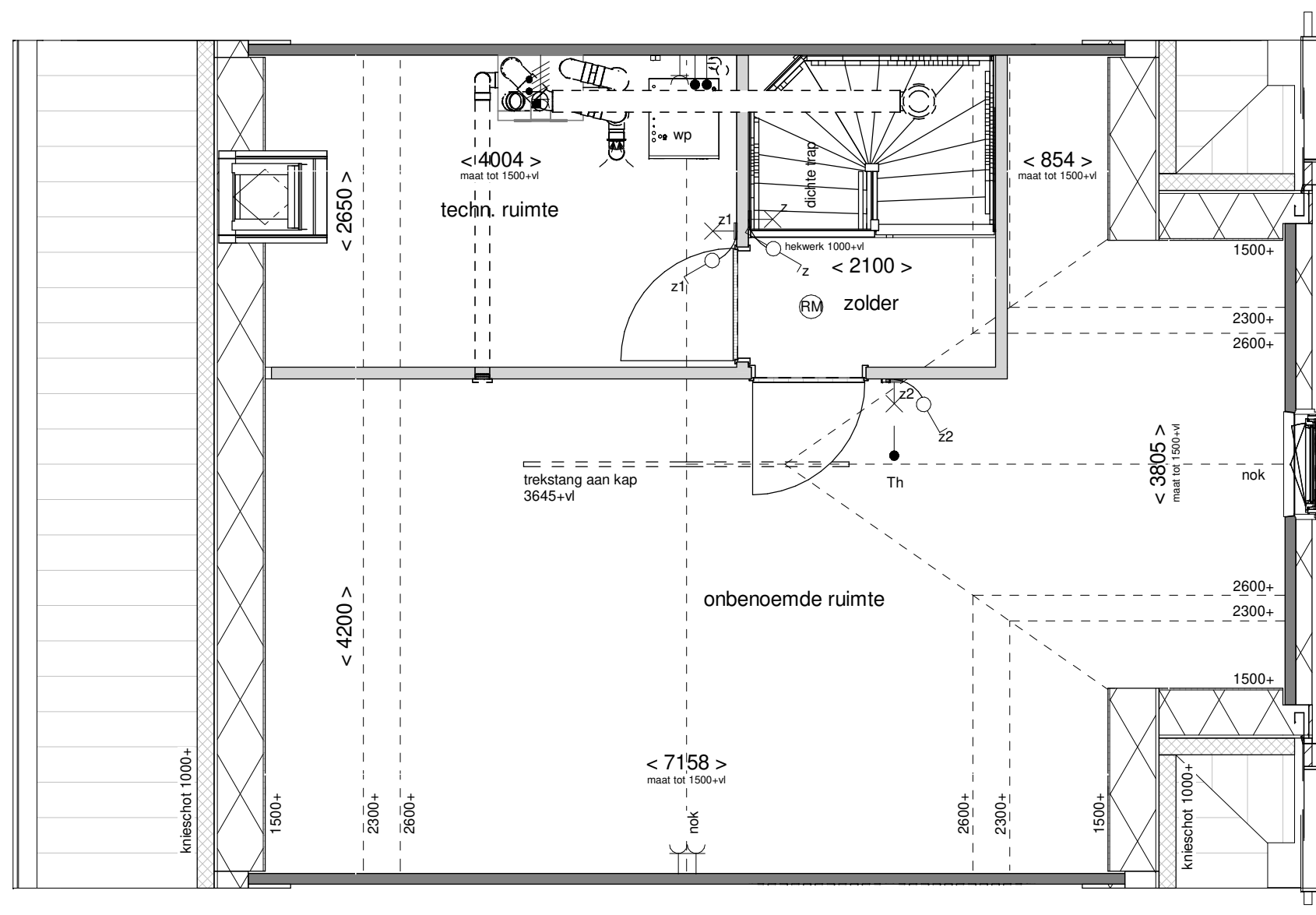

Optie: Indeling met 1 onbenoemde ruimte

Woningtype: L72T

Bouwnummer: \_\_\_\_\_

Optienummer: 1.C.L.72

Schaal: 1:50

Datum: 18-04-2023

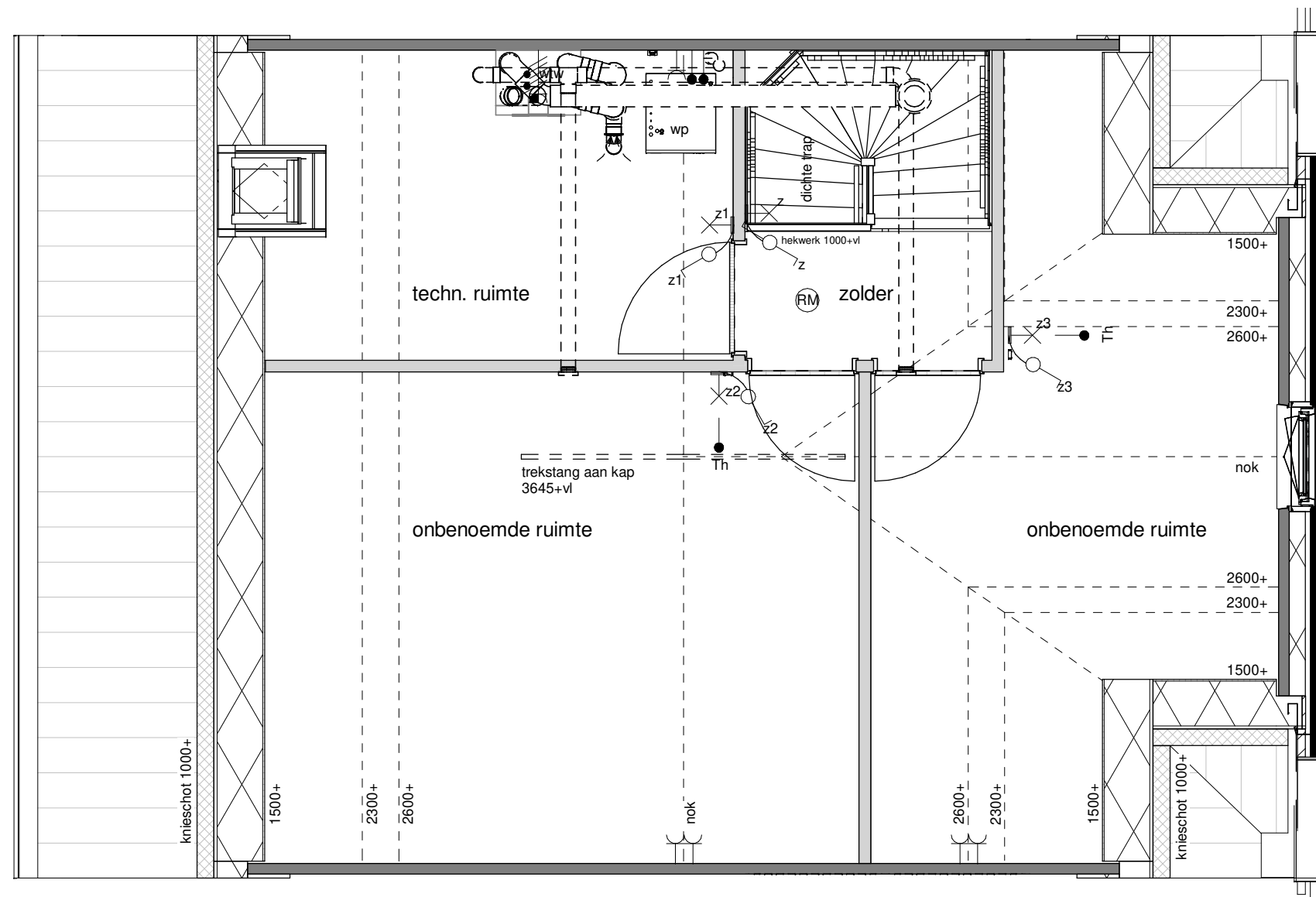

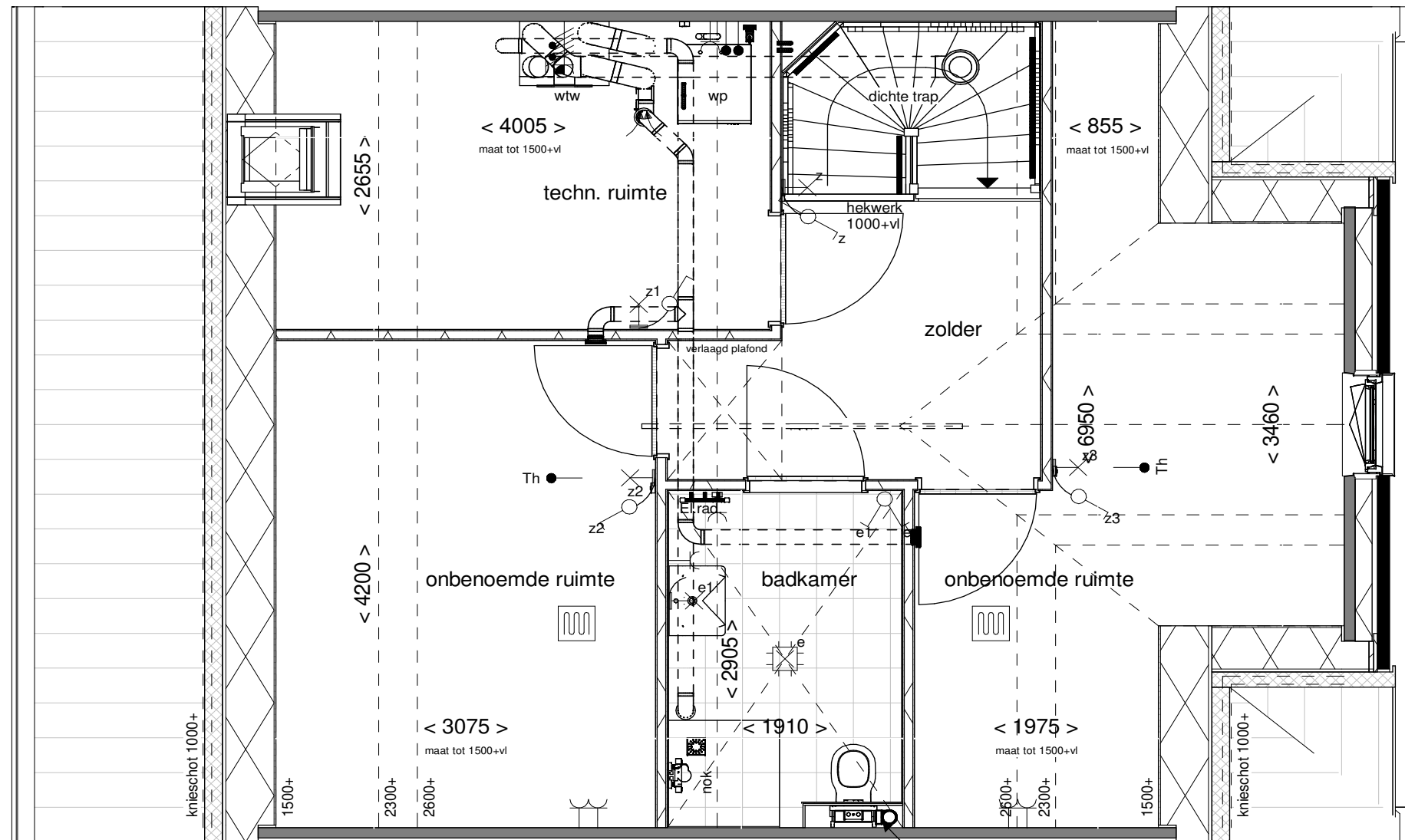

extra leiding koper op  
de begane grond



Optie: Indeling met badkamer  
tech.- en 2 onb. ruimtes

Woningtype: L72

Bouwnummer:

Optienummer: 1.C.L.75

Schaal: 1:50

Datum: 18-04-2023



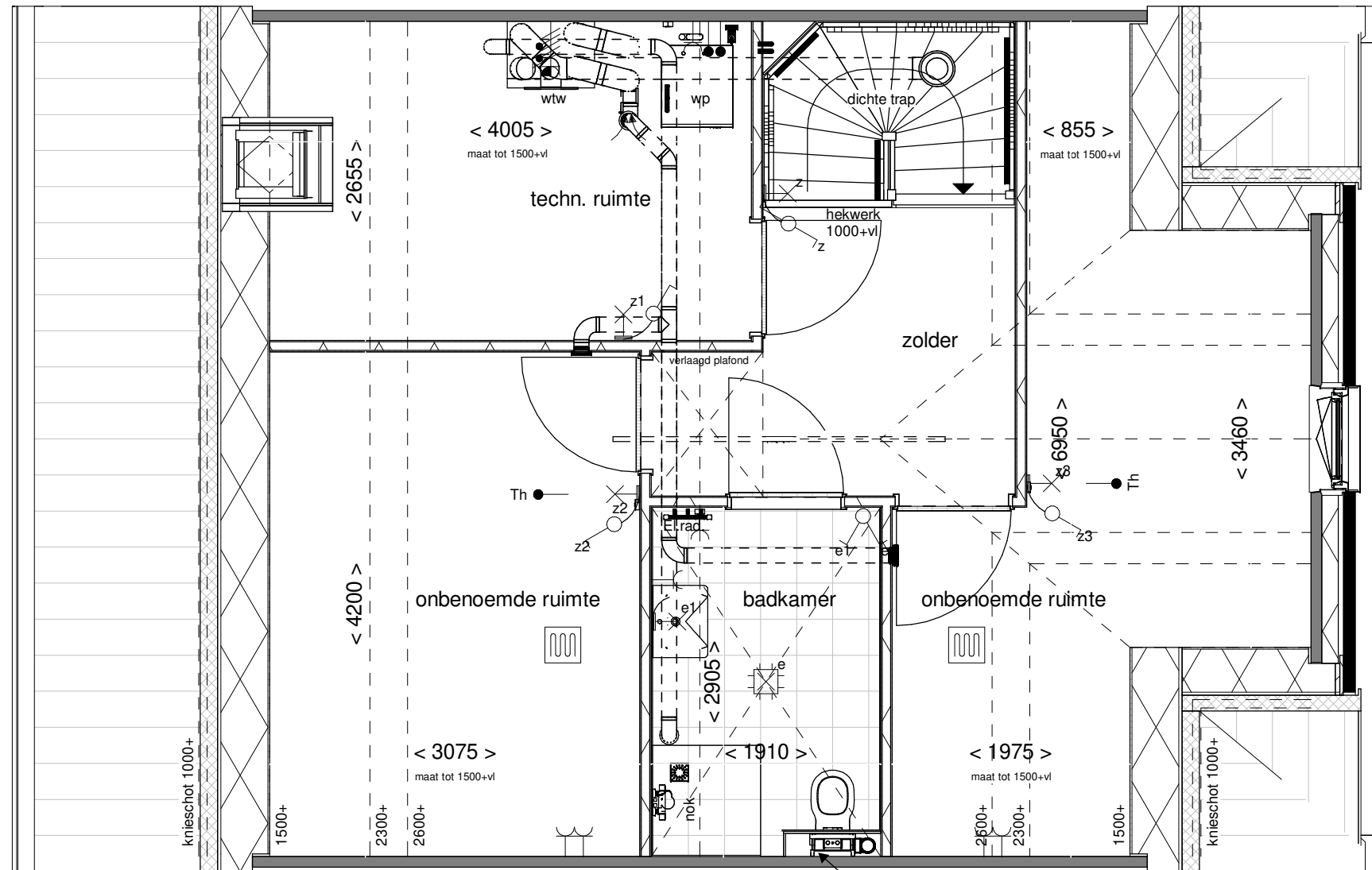

extra leiding koker op de begane grond

Badkamer begane grond komt te vervallen



Optie: Indeling met badkamer  
tech.- en 2 onb. ruimtes

Woningtype: L72

Bouwnummer:

Optienummer: 1.C.L.75A

Schaal: 1:50

Datum: 18-04-2023