





















Renvooi

-  - entree woning
-  - erfgrans
-  - P1 parkeervak eigen terrein
-  - buitenunit warmtepomp
-  - leiding buitenunit
-  - mantelbuis t.b.v. nuts
-  - haag H=600mm
-  - schutting H=1800mm
-  - hekwerk op houten damwand
-  - schutting H=2100mm
-  - gaashek met klimplanten H=1800mm
-  - plantenrol
-  - stalen poort
-  - mandelig terrein
-  - speeltuin
-  - transformatorhuis
-  - opstelplaats vuilcontainer
-  - ondergronds containers
-  - hellingbaan
-  - talud
-  - lage houten beschoeiing

parkeerplekken en posities bomen indicatief

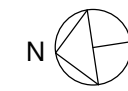

Tekening: **Situatie Blok 34**

Woningtype: **C60**

Bouwnummer: **136 t/m 138**

Bladnummer: **VT-34-S01**

Schaal: **1:200**

Datum: **19-12-2023**



Renvooi materialen

	dakpan donkergrijs
	dakpan grijs
	dakpan rood
	metselwerk kleur rood
	metselwerk kleur bruin
	metselwerk kleur geel
	metselwerk kleur wit
	metselwerk kleur oranje
	metselwerk kleur roodbruin
	metselwerk kleur grijs
	Gevelbetimmering vezelcement, lood
	Gevelbetimmering vezelcement, roomwit

Renvooi bouwkundig

	entree woning
	metselwerk
	isolatie
	dragende wand
	niet dragende binnenwand
	binnendeurkozijn (met bovenlicht)
	kruipluik
	opstelplaats wasmachine
	opstelplaats wasdroger
	opstelplaats koelkast
	principe opstelling keukenblok (elektra conform nultekeningen Bruynzeel)
	onbenoemde ruimte volgens krijtstreepmethode

Renvooi installaties

	aansluitpunt licht, wand
	centraaldoos met lichtpunt
	armatuur aan de wand
	rookmelder
	aansluitpunt niet bedraad / loos
	beldrukker
	schel
	schakelaar, 1-polig
	werkschakelaar tbv PV-panelen
	driestandenschakelaar tbv wtw
	schakelaar, wissel
	schakelaar, serie
	pulsschakelaar tbv warmteterugwinunit
	wandcontactdoos 1-voudig met beschermingscontact
	wandcontactdoos 2-voudig met beschermingscontact
	thermostaatleiding, bedraad
	wandcontactdoos tbv warmteterugwinunit
	wtw mechanische ventilatie-unit incl. warmteterugwinunit
	wp warmtepomp
	inblaasventiel mechanische ventilatie
	afzuigventiel mechanische ventilatie
	wv verdeler vloerverwarming
	ruimte vzv vloerverwarming
	rad elektrische radiator
	kanalen in het zicht
	doucheput
	lijngoot douche

Disclaimer

De op deze tekeningen aangegeven maten zijn circa maten in millimeters en tussen de wanden / vloeren gemeten, waarbij geen rekening is gehouden met enige wandafwerking, plinten, aftimmering, etc. In verband met de nauwkeurige uitwerking van details, constructie, maatvoering, materialen e.d. kunnen er kleine afwijkingen ontstaan ten opzichte van de nu vermelde gegevens. Deze geringe afwijkingen geven geen aanleiding tot verrekening. Aan de op deze tekening aangegeven maten kunnen derhalve geen rechten worden ontleend. De op deze tekeningen aangegeven maatvoering is niet geschikt voor opdrachten aan derden door koper(s). De posities van aansluitingen en installatie onderdelen zijn indicatief op tekening aangegeven. De exacte aantallen en posities zullen na berekening in het werk door de installateurs worden bepaald en kunnen afwijken van deze tekening.



Tekening: Renvooi

Woningtype: -

Bouwnummer:

Bladnummer: VT-0-00c

Schaal:

Datum: 04-04-2023



Linker zijgevel

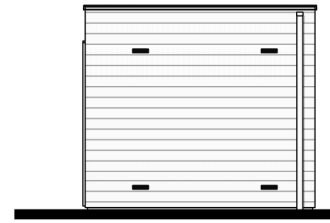

Voorgevel



Rechter zijgevel

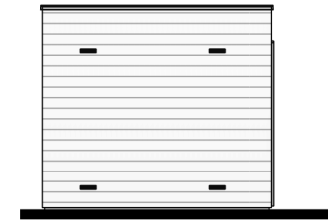

Achtergevel

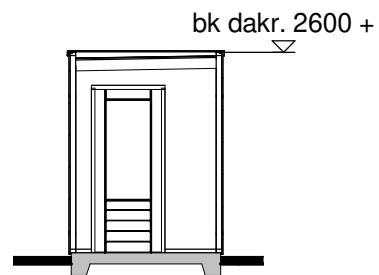

Doorsnede A

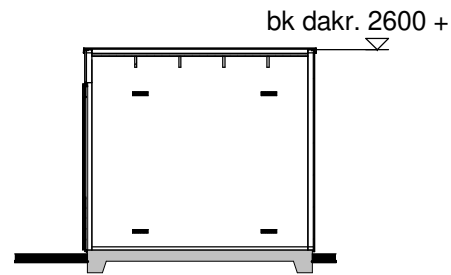

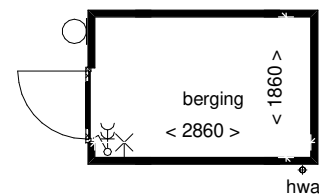

Doorsnede B







Begane grond

Renvooi

-  houten rabatdelen
-  houten wanden

Installaties

-  - enkelpolige schakelaar
-  - dubbele wandcontactdoos
-  - lichtpunt buiten
-  - lichtpunt aan wand

Disclaimer

De op deze tekening aangegeven maten zijn circa maten in millimeters en tussen de wanden / vloeren gemeten, waarbij geen rekening is gehouden met enige wandafwerking, plinten, aftimmering, etc. In verband met de nauwkeurige uitwerking van details, constructie, maatvoering, materialen e.d. kunnen er kleine afwijkingen ontstaan ten opzichte van de nu vermelde gegevens. Deze geringe afwijkingen geven geen aanleiding tot verrekening. Aan de op deze tekening aangegeven maten kunnen derhalve geen rechten worden ontleend. De op deze tekening aangegeven maatvoering is niet geschikt voor opdrachten aan derden door koper(s). De posities van aansluitingen en installatie onderdelen zijn indicatief op tekening aangegeven. De exacte aantallen en posities zullen na berekening in het werk door de installateurs worden bepaald en kunnen afwijken van deze tekening.

3D Impressie

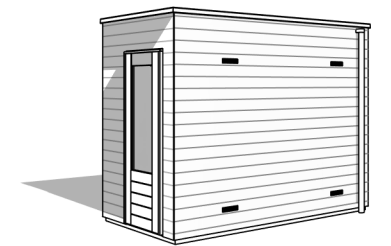

BENT
WIJCK
 BENTHUIZEN

Tekening: Berging enkel

Bouwnummer: 50,61,75,76,79,82,102,
103,127,138

Bladnummer: VT-00-B2-fase 2-3

Schaal: 1:100

Datum: 18-04-2023

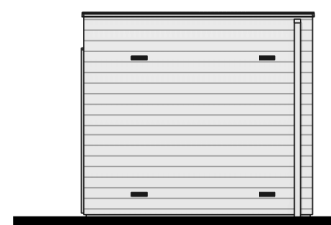

Voorgevel

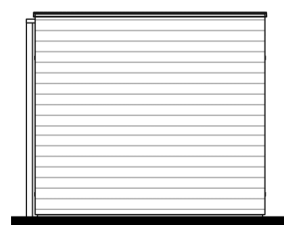

Rechter zijgevel

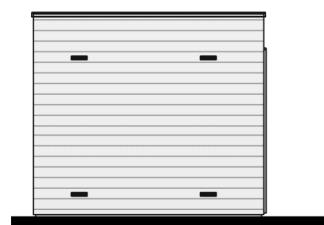

Achtergevel

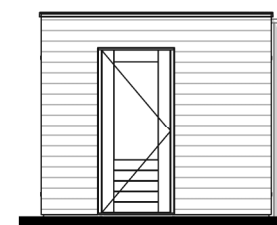

Linker zijgevel

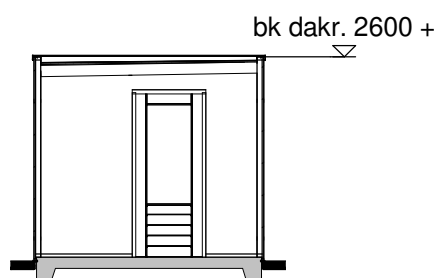

Doorsnede A

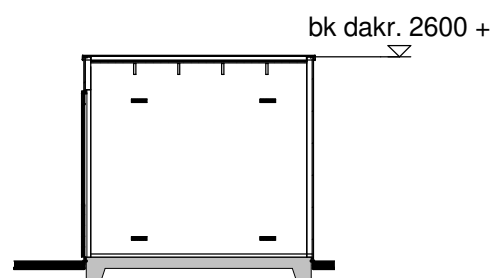

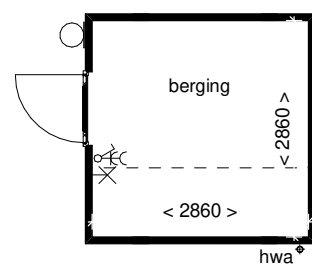

Doorsnede B







Begane grond

Renvooi

-  houten rabatdelen
-  houten wanden

Installaties

-  - enkelpolige schakelaar
-  - dubbele wandcontactdoos
-  - lichtpunt buiten
-  - lichtpunt aan wand

Disclaimer

De op deze tekening aangegeven maten zijn circa maten in millimeters en tussen de wanden / vloeren gemeten, waarbij geen rekening is gehouden met enige wandafwerking, plinten, aftimmering, etc. In verband met de nauwkeurige uitwerking van details, constructie, maatvoering, materialen e.d. kunnen er kleine afwijkingen ontstaan ten opzichte van de nu vermelde gegevens. Deze geringe afwijkingen geven geen aanleiding tot verrekening. Aan de op deze tekening aangegeven maten kunnen derhalve geen rechten worden ontleend. De op deze tekening aangegeven maatvoering is niet geschikt voor opdrachten aan derden door koper(s). De posities van aansluitingen en installatie onderdelen zijn indicatief op tekening aangegeven. De exacte aantallen en posities zullen na berekening in het werk door de installateurs worden bepaald en kunnen afwijken van deze tekening.

3D Impressie

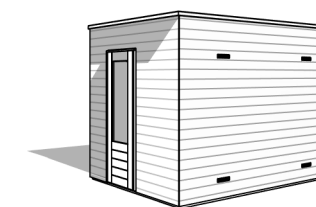

Tekening: Optie verbreden berging enkel, dubbel

Bouwnummer: 46-63,75-88,96-105, 117-138

Bladnummer: VT-00-B5-fase 2-3

Schaal: 1:100

Datum: 18-04-2023



Type: C60U-1
Bouwnummer:136

Type: C60-4
Bouwnummer:137

Type: C60U-1
Bouwnummer:138

Voorgevel



Type: C60U-1
Bouwnummer:138

Type: C60-4
Bouwnummer:137

Type: C60U-1
Bouwnummer:136

Achtergevel



Tekening: Gevels blok 34

Woningtype: C60U-1/C60-4

Bouwnummer: 136 t/m 138

Bladnummer: VT-C34-00a

Schaal: 1:100

Datum: 18-04-2023



Type: C60U-1
Bouwnummer: 136

Linker zijgevel



Type: C60U-1
Bouwnummer: 138

Rechter zijgevel



Tekening: Zijgevels blok 34

Woningtype: C60U-1/C60-4

Bouwnummer: 136 t/m 138

Bladnummer: VT-C34-00b

Schaal: 1:100

Datum: 18-04-2023

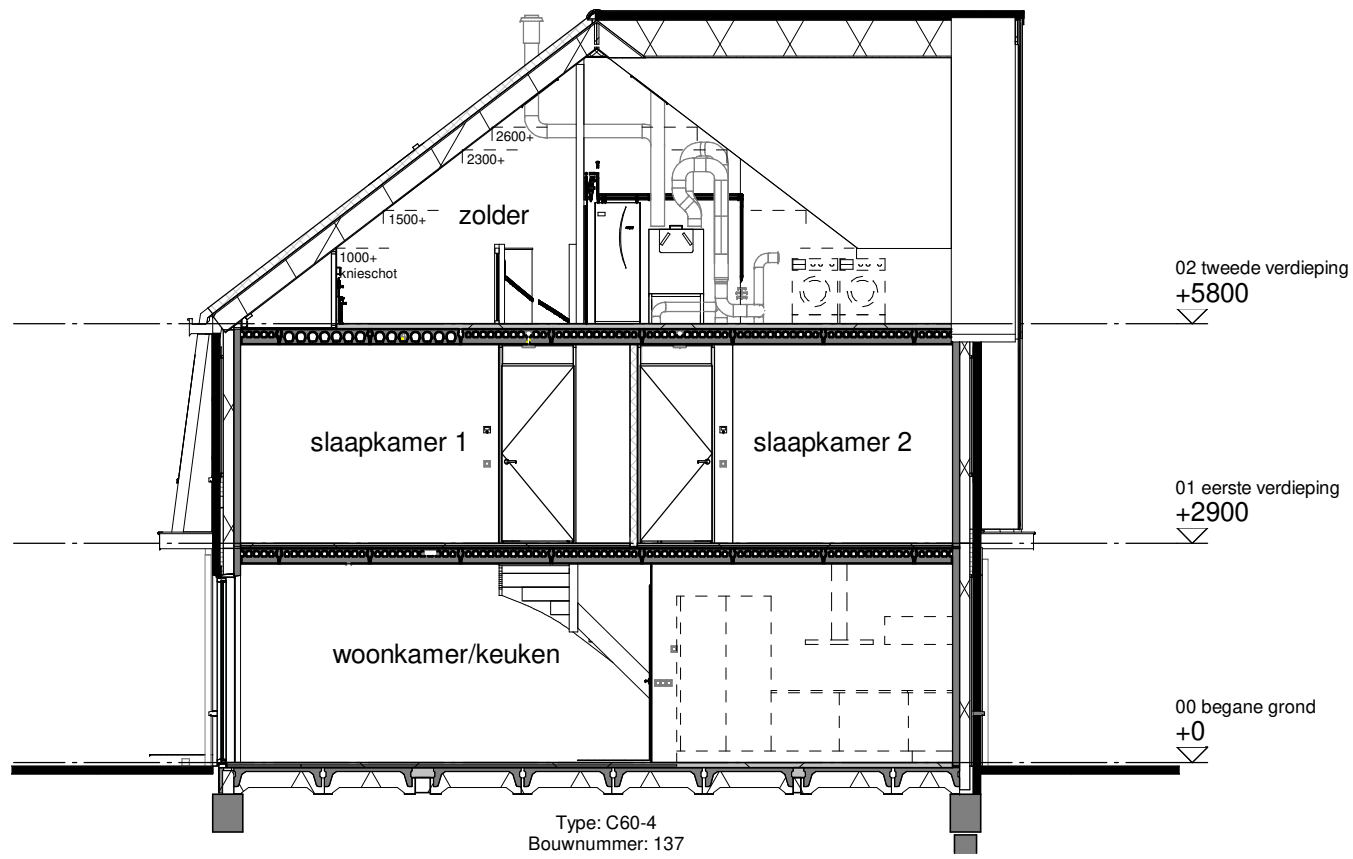

Doorsnede A

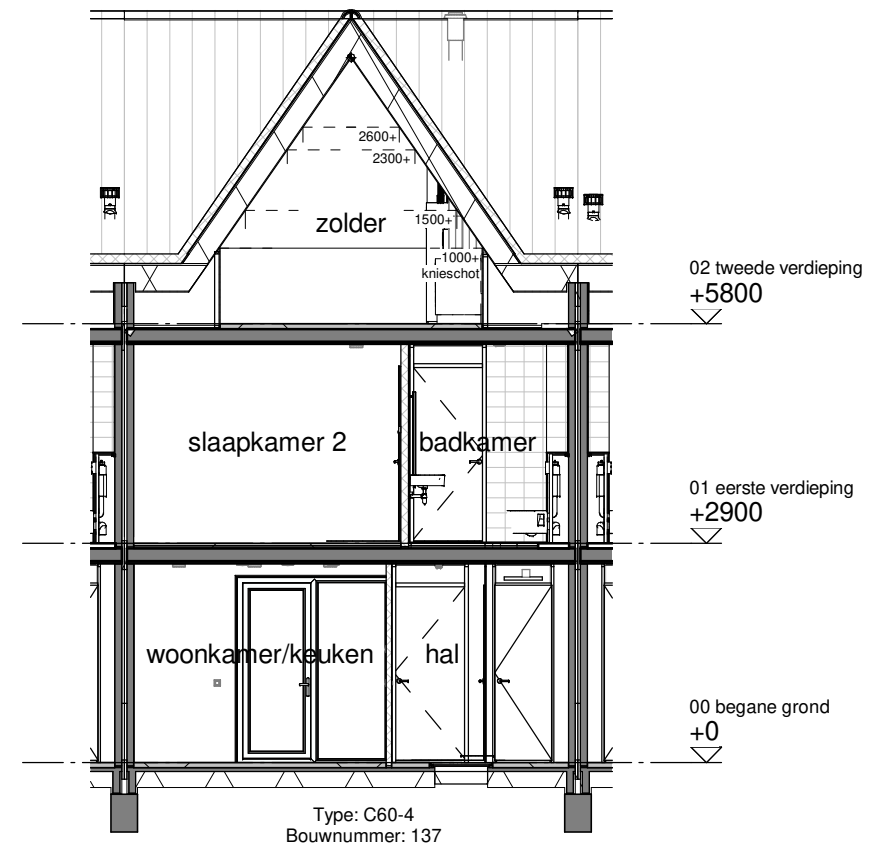

Doorsnede B

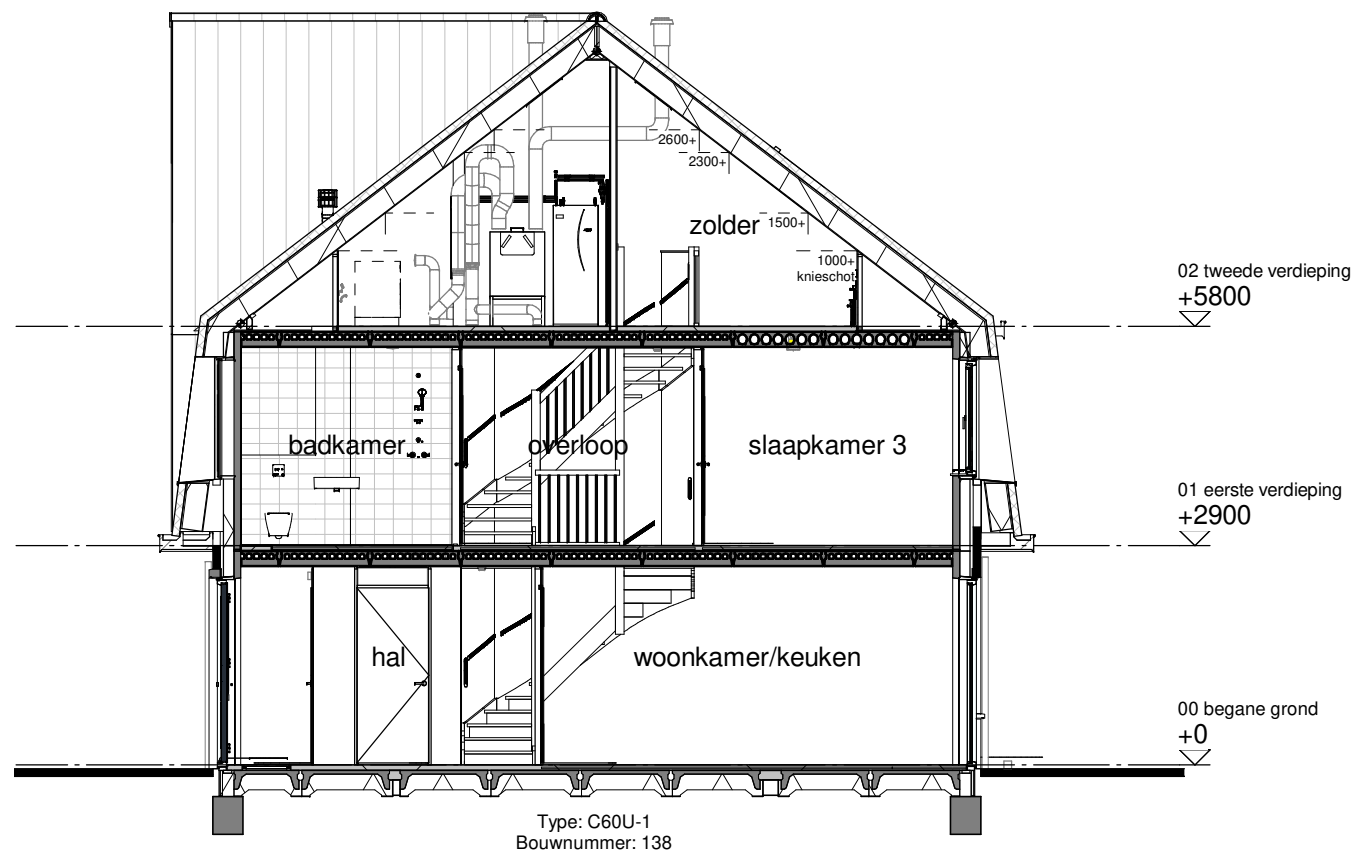

Doorsnede C

Tekening: Doorsneden blok 34

Woningtype: C60U-1, C60-4

Bouwnummer: 136-138

Bladnummer: VT-C34-00c

Schaal: 1:100

Datum: 18-04-2023

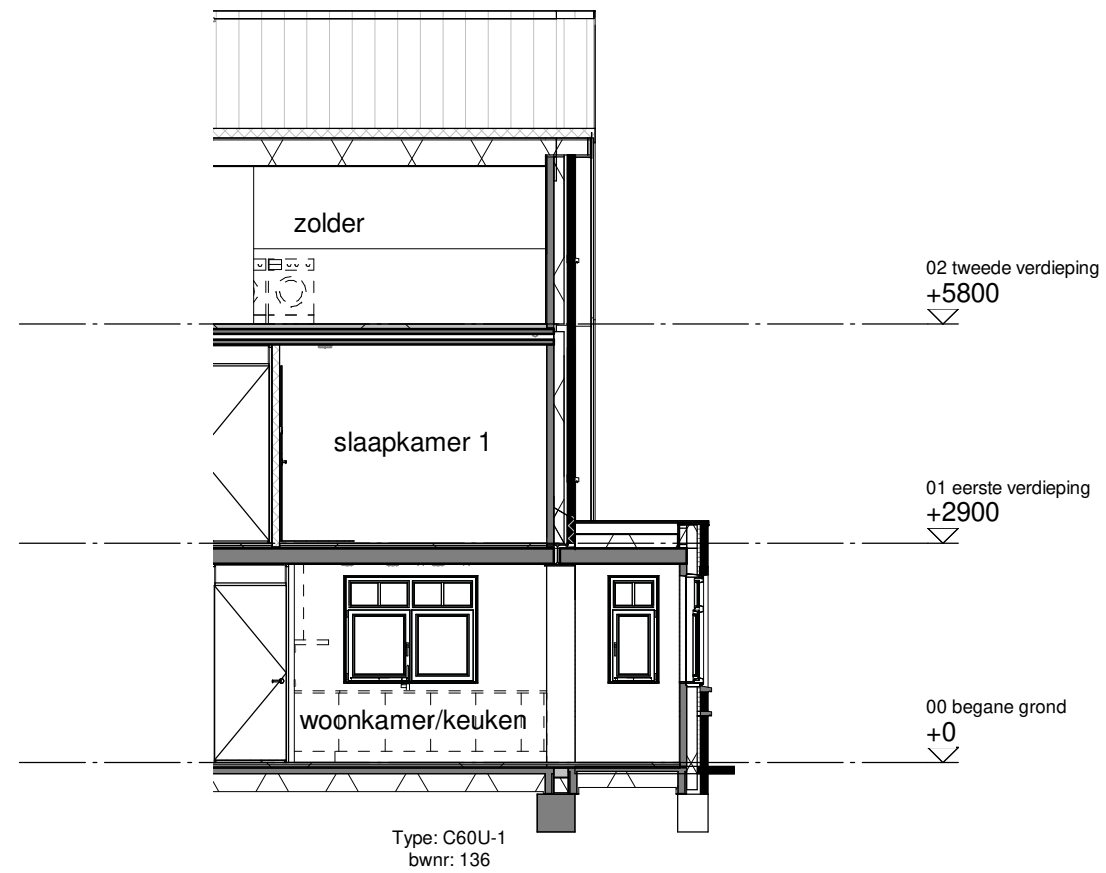

Doorsnede D

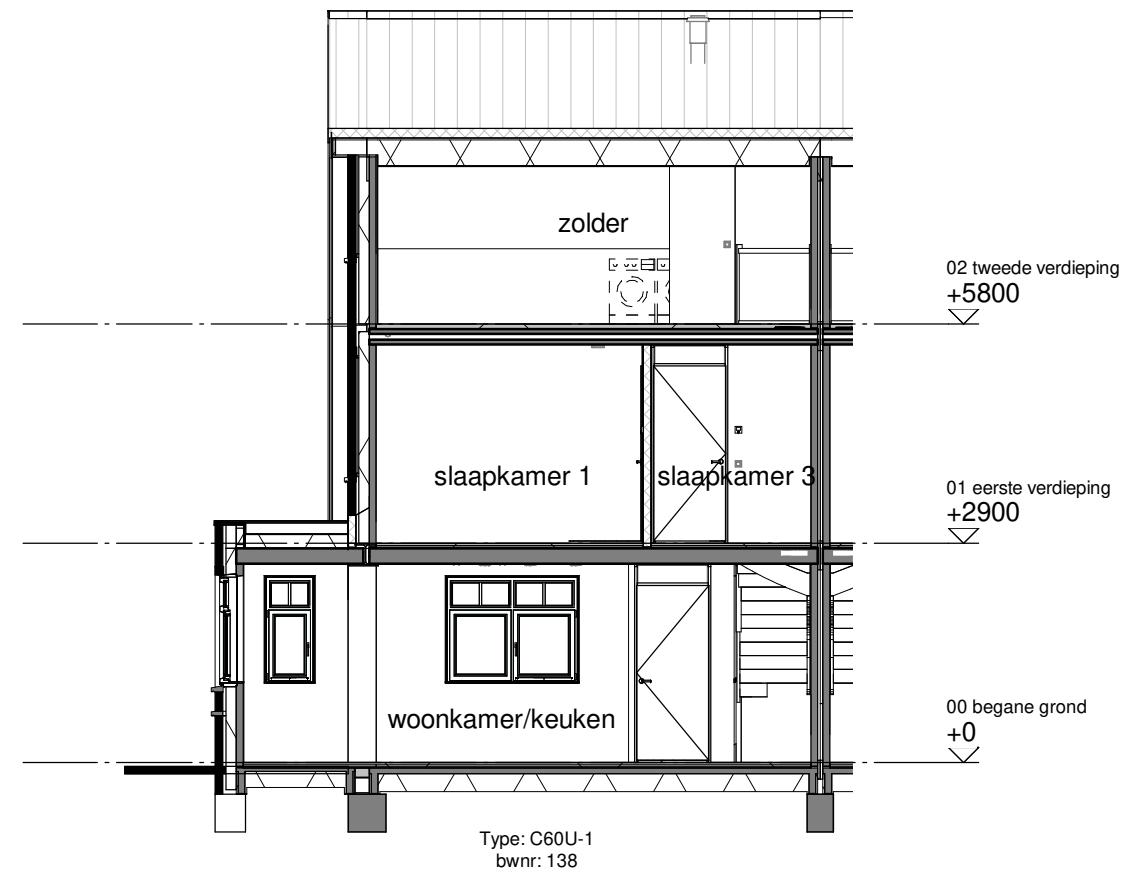

Doorsnede E

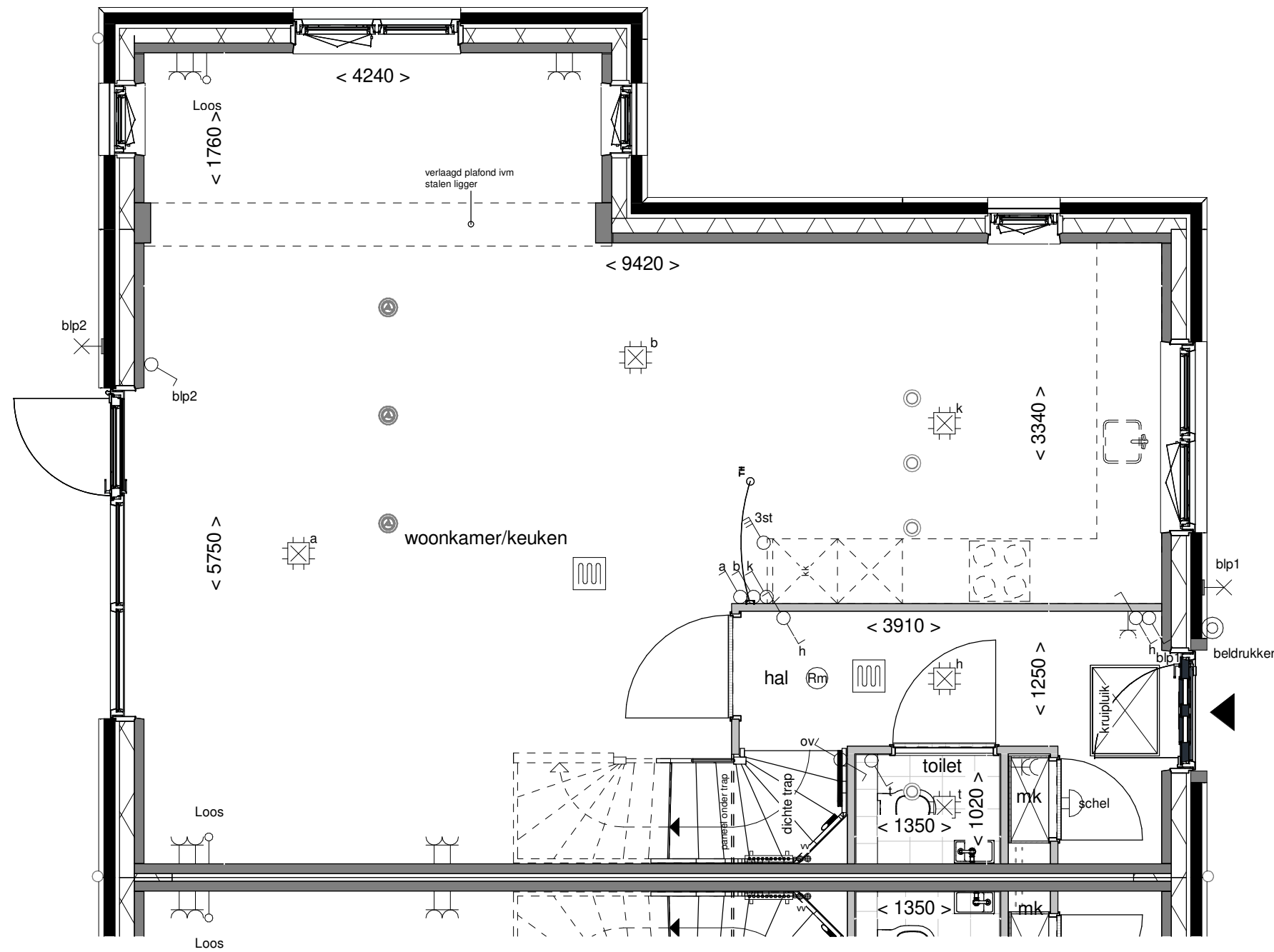

Tekening: Begane grond

Woningtype: C60U-1

Bouwnummer: 138

Bladnummer: VT-C-138a

Schaal: 1:50

Datum: 18-04-2023

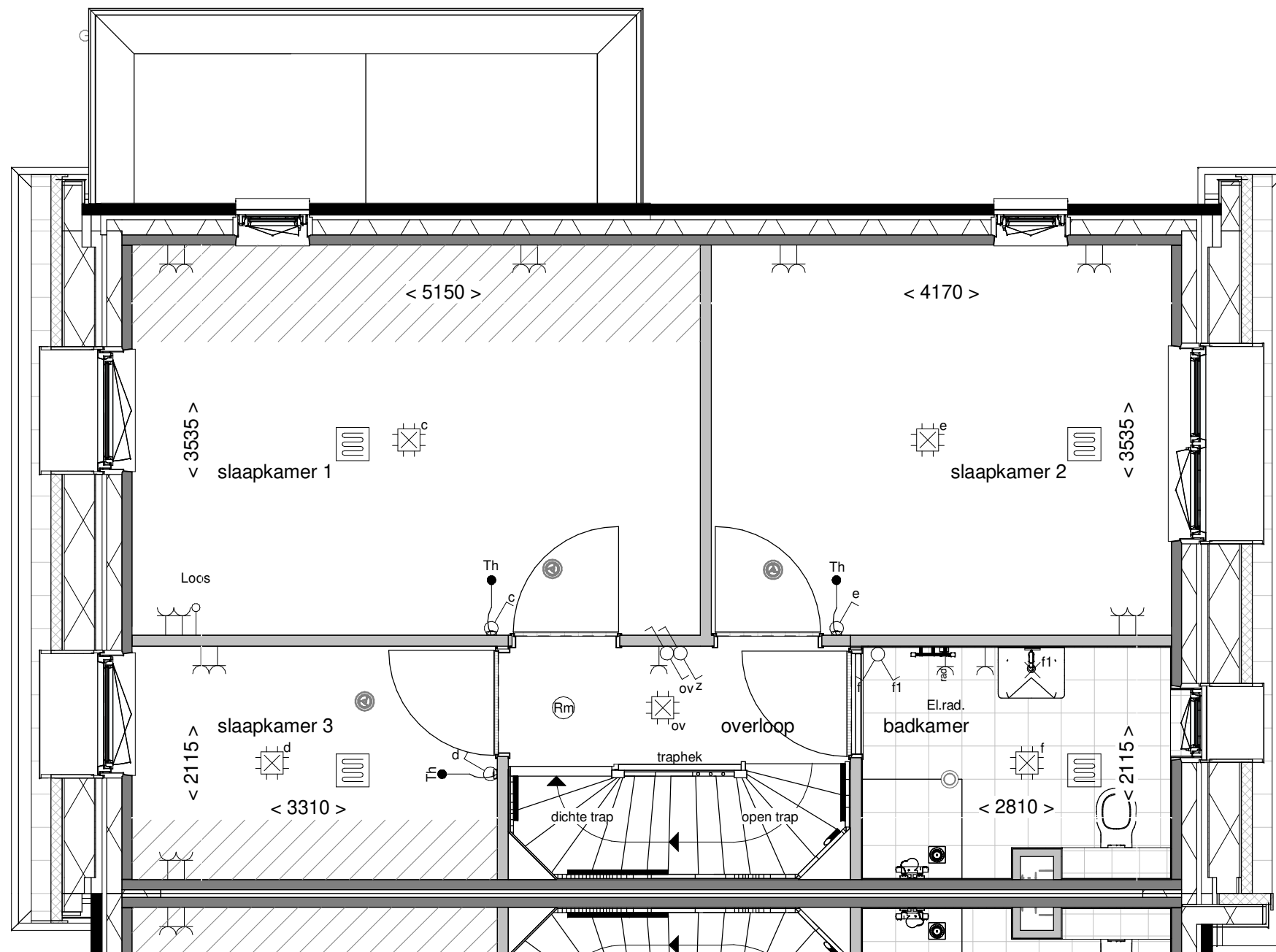

Tekening: **Eerste verdieping**

Woningtype: **C60U-1**

Bouwnummer: **138**

Bladnummer: **VT-C-138b**

Schaal: **1:50**

Datum: **18-04-2023**

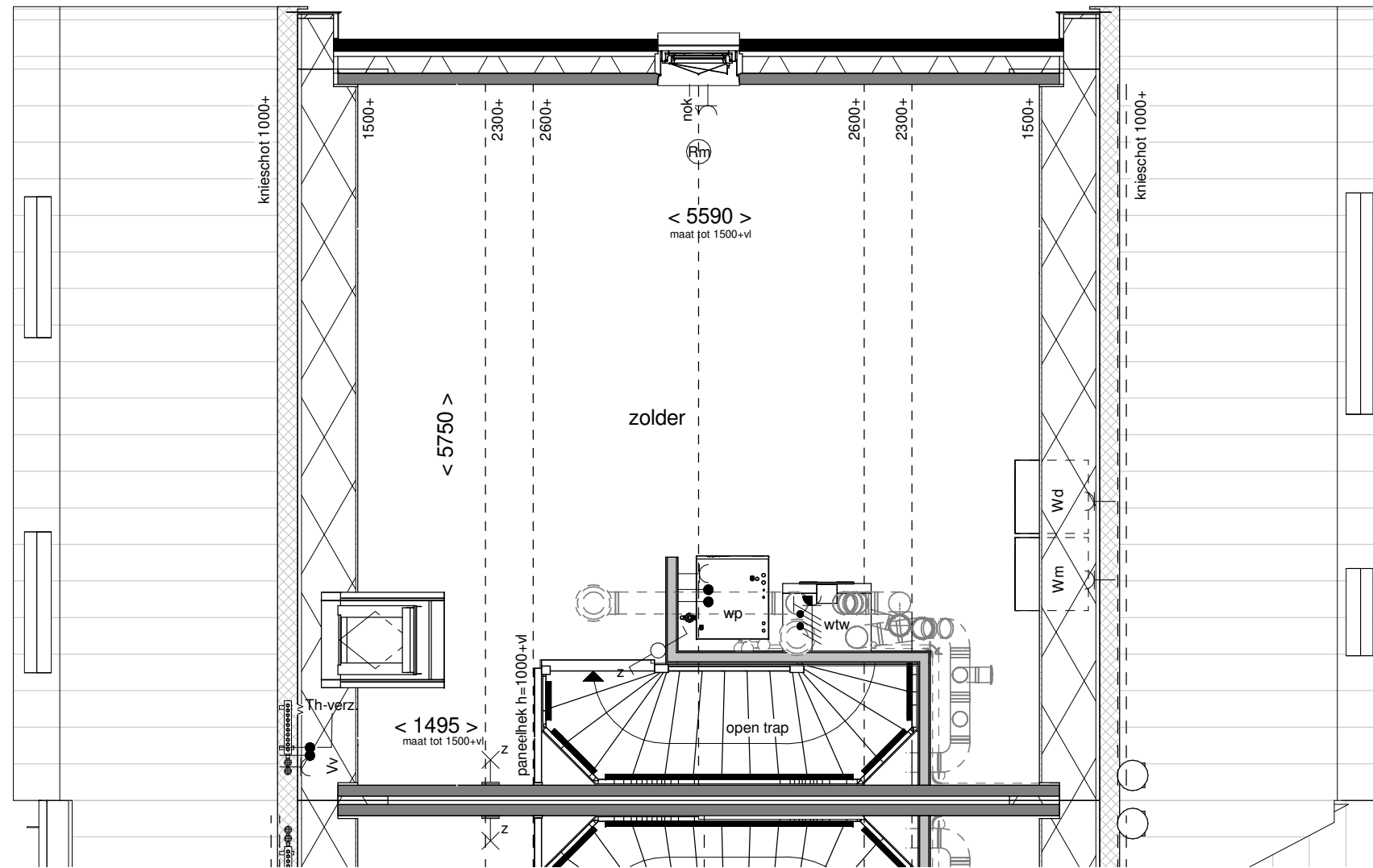

Tekening: Tweede verdieping

Woningtype: C60U-1

Bouwnummer: 138

Bladnummer: VT-C-138c

Schaal: 1:50

Datum: 18-04-2023

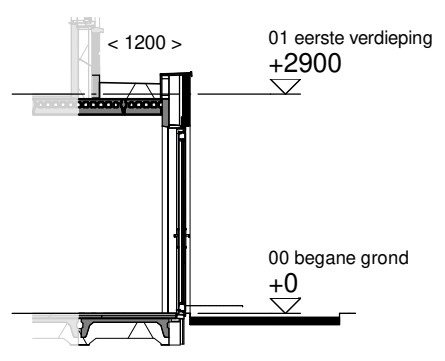
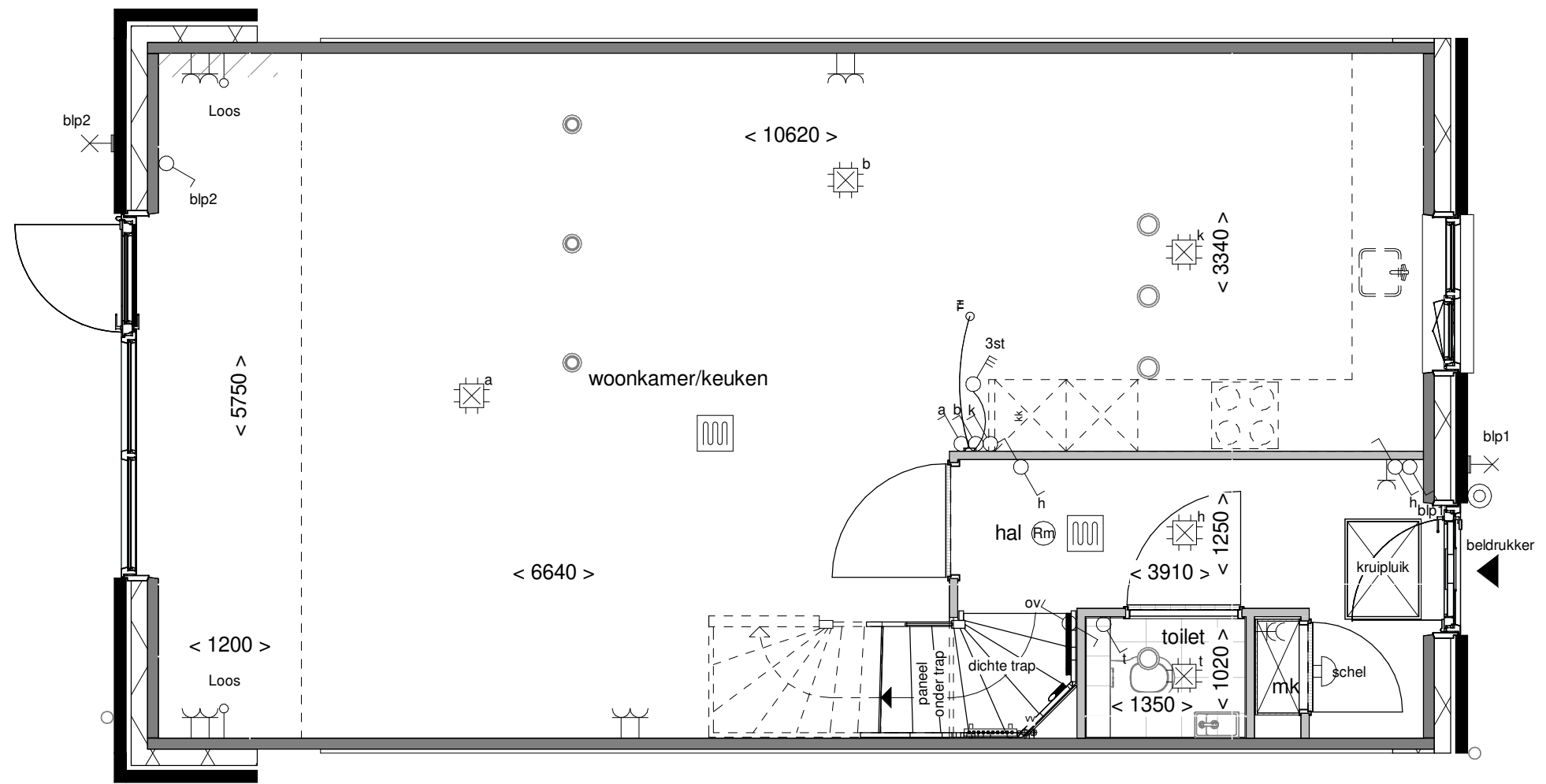

Doorsnede schaal 1:100



Achtergevel schaal 1:100



Optie: **Uitbouw achtergevel 120cm**

Woningtype: **C60**

Bouwnummer: -

Optienummer: **1.A.X.18**

Schaal: **1:50 / 1:100**

Datum: **18-04-2023**

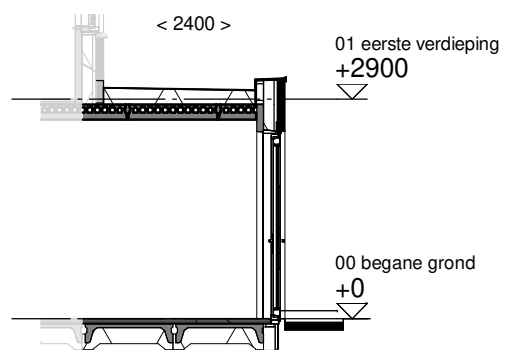
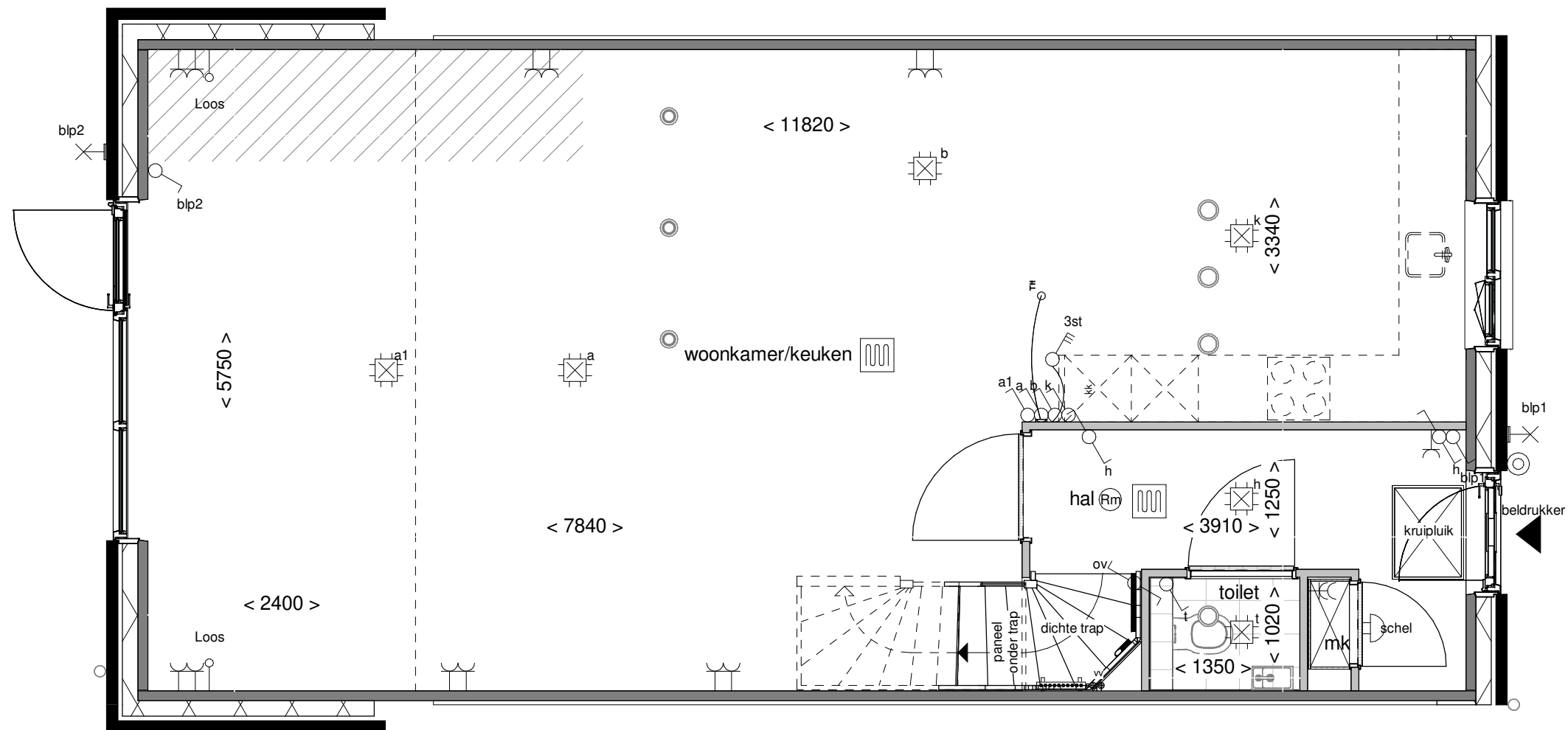

Doorsnede schaal 1:100



Achtergevel schaal 1:100

**BENT
WIJCK**
BENTHUIZEN

Optie: **Uitbouw achtergevel
240cm**

Woningtype: **C60**

Bouwnummer: -

Optienummer: **1.A.X.38**

Schaal: **1:50 / 1:100**

Datum: **18-04-2023**

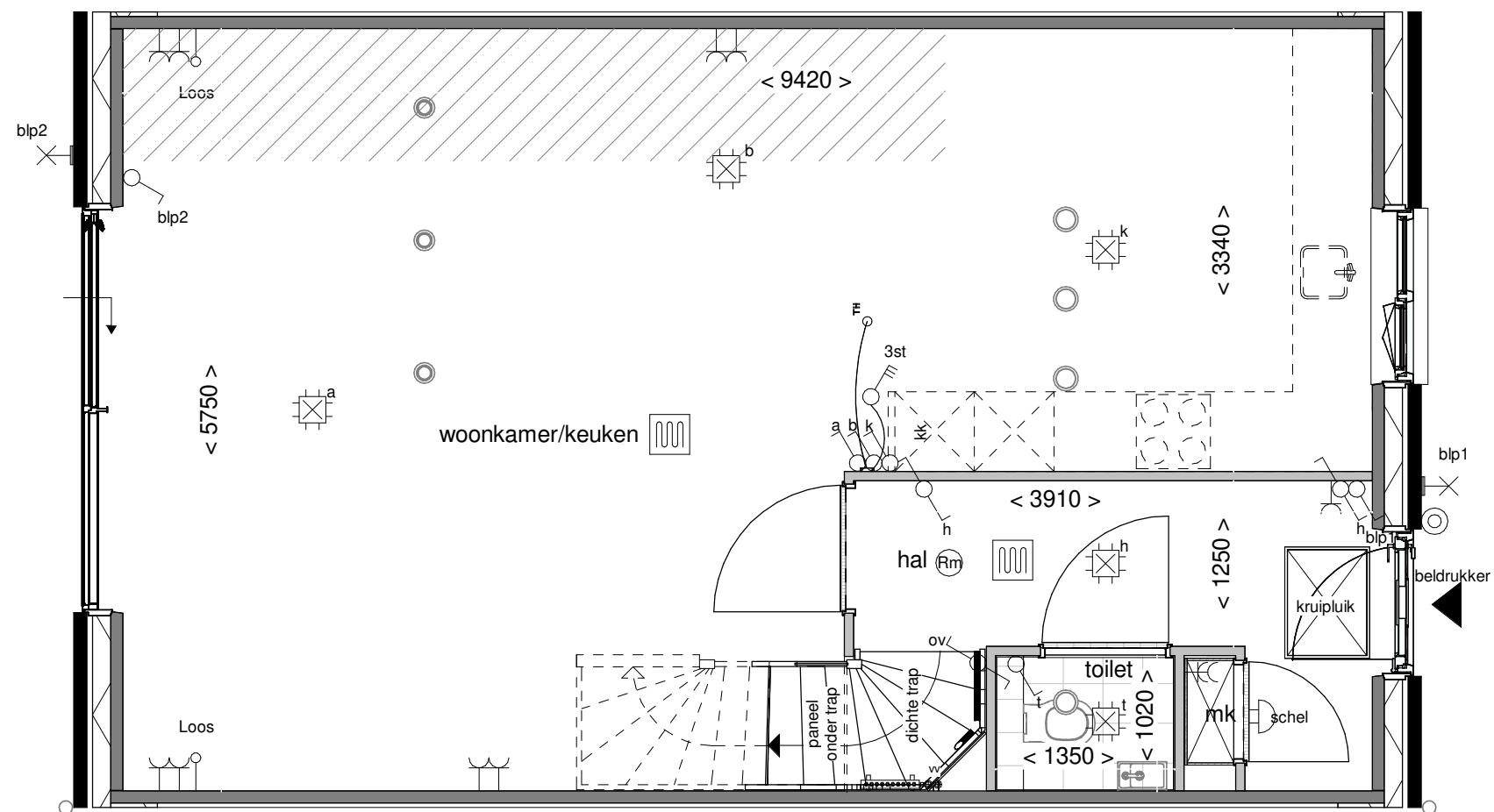

Achtergevel schaal 1:100

**BENT
WIJCK**
BENTHUIZEN

Optie: Aluminium schuifpui

Woningtype: C60

Bouwnummer: -

Optienummer: 1.A.X.52

Schaal: 1:50 / 1:100

Datum: 18-04-2023

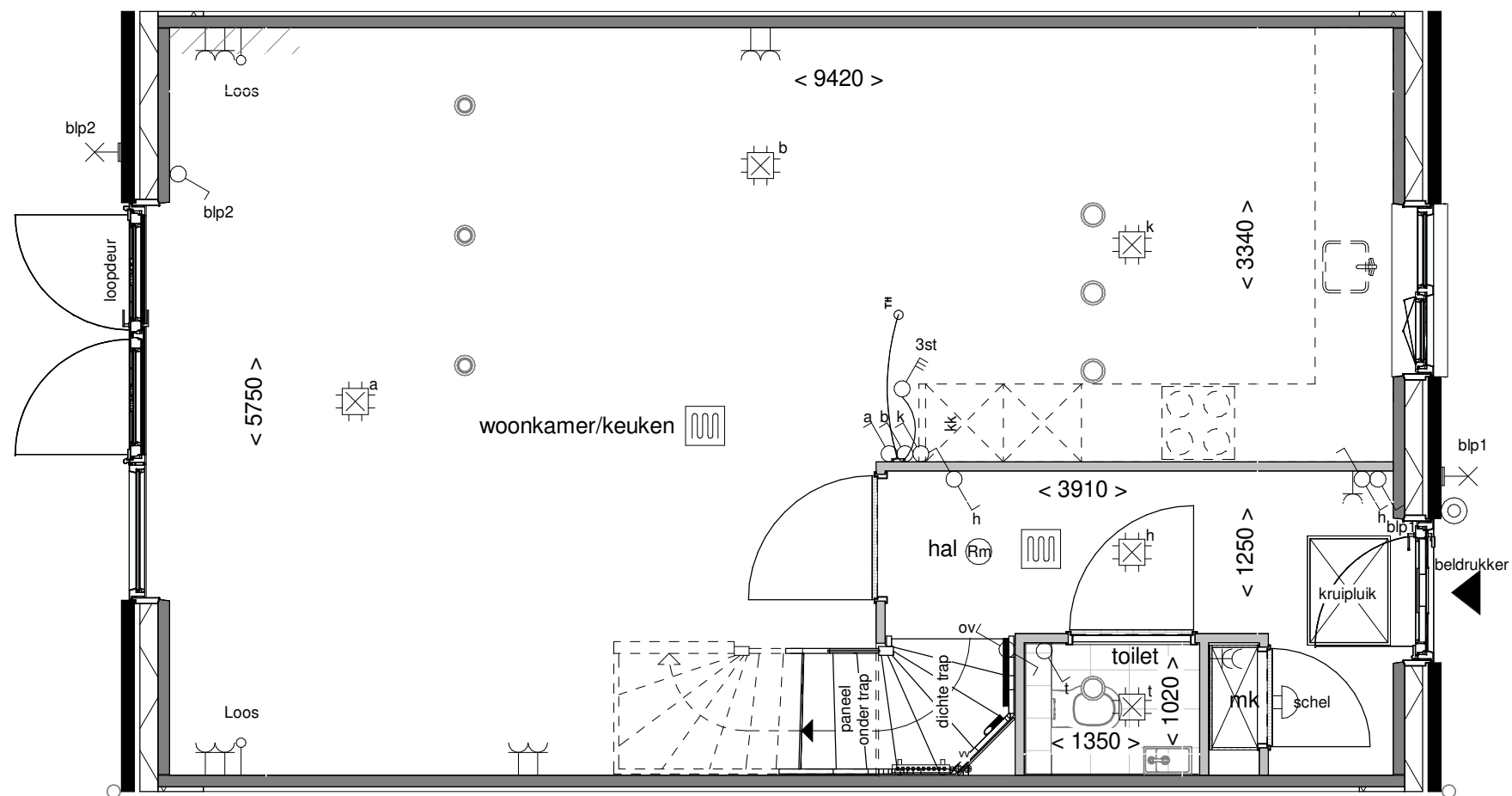

Achtergevel schaal 1:100

**BENT
WIJCK**
BENTHUIZEN

Optie: Openslaande deuren met 1 zijlicht

Woningtype: C60

Bouwnummer: -

Optienummer: 1.A.X.58

Schaal: 1:50 / 1:100

Datum: 18-04-2023

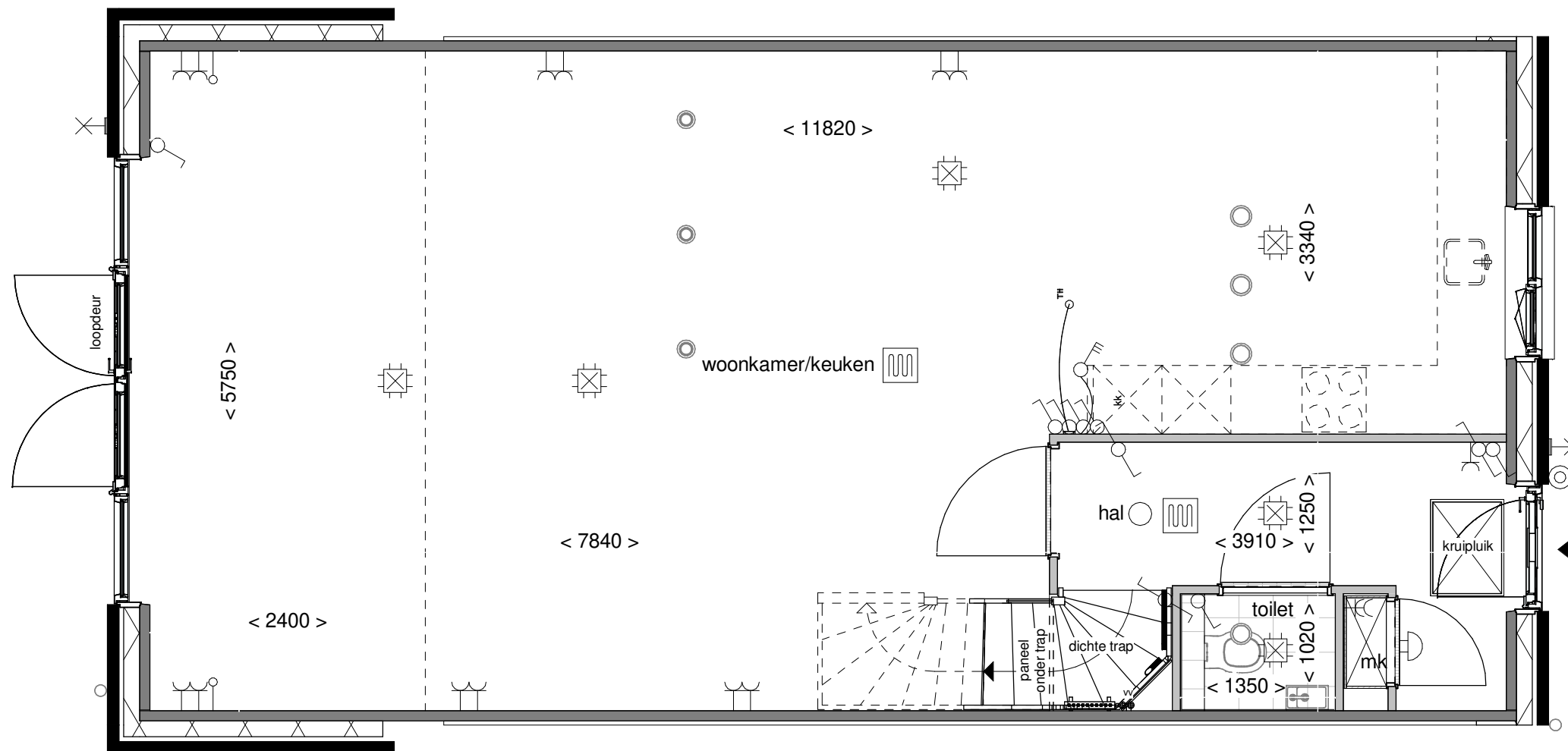

Achtergevel schaal 1:100



Optie: Openslaande deuren met 2 zijlichten

Woningtype: C60

Bouwnummer: -

Optienummer: 1.A.X.62

Schaal: 1:50 / 1:100

Datum: 18-04-2023

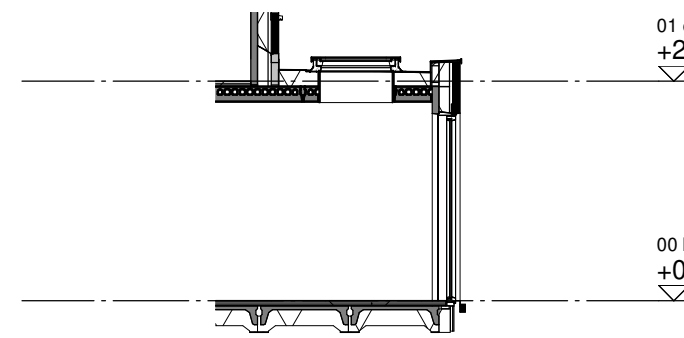
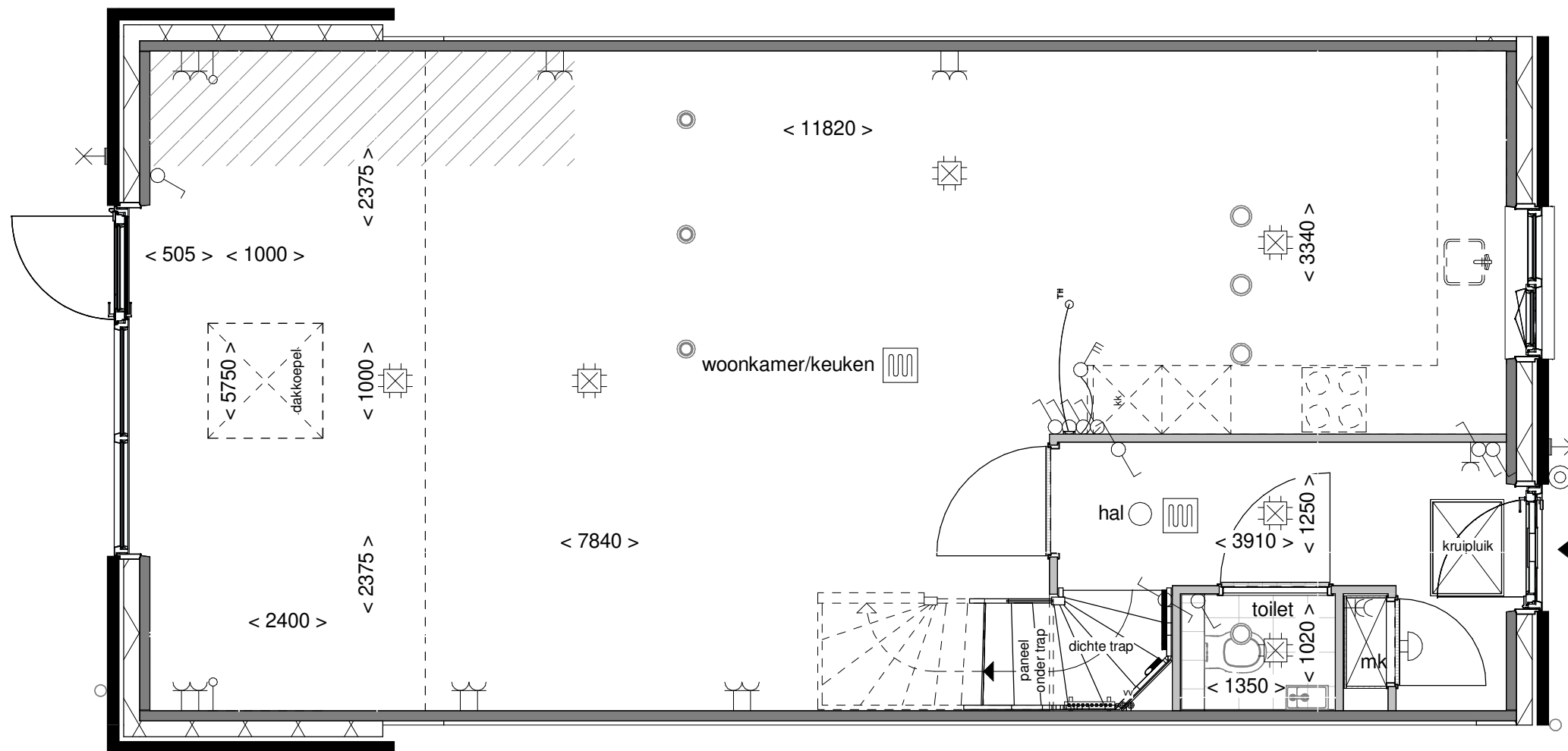

Doorsnede schaal 1:100

**BENT
WIJCK**
BENTHUIZEN

01 eerste verdieping
+2900

Optie: Lichtkoepel in uitbouw 240cm

Woningtype: C60

Bouwnummer: -

Optienummer: 1.B.X.10

Schaal: 1:50 / 1:100

Datum: 18-04-2023

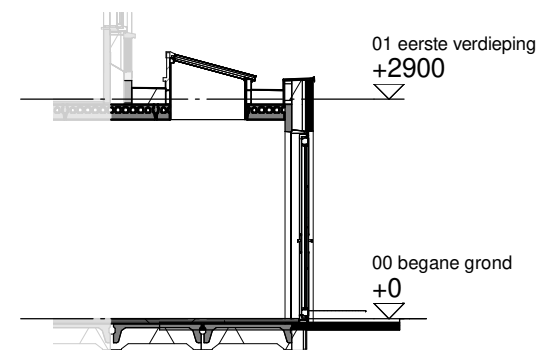
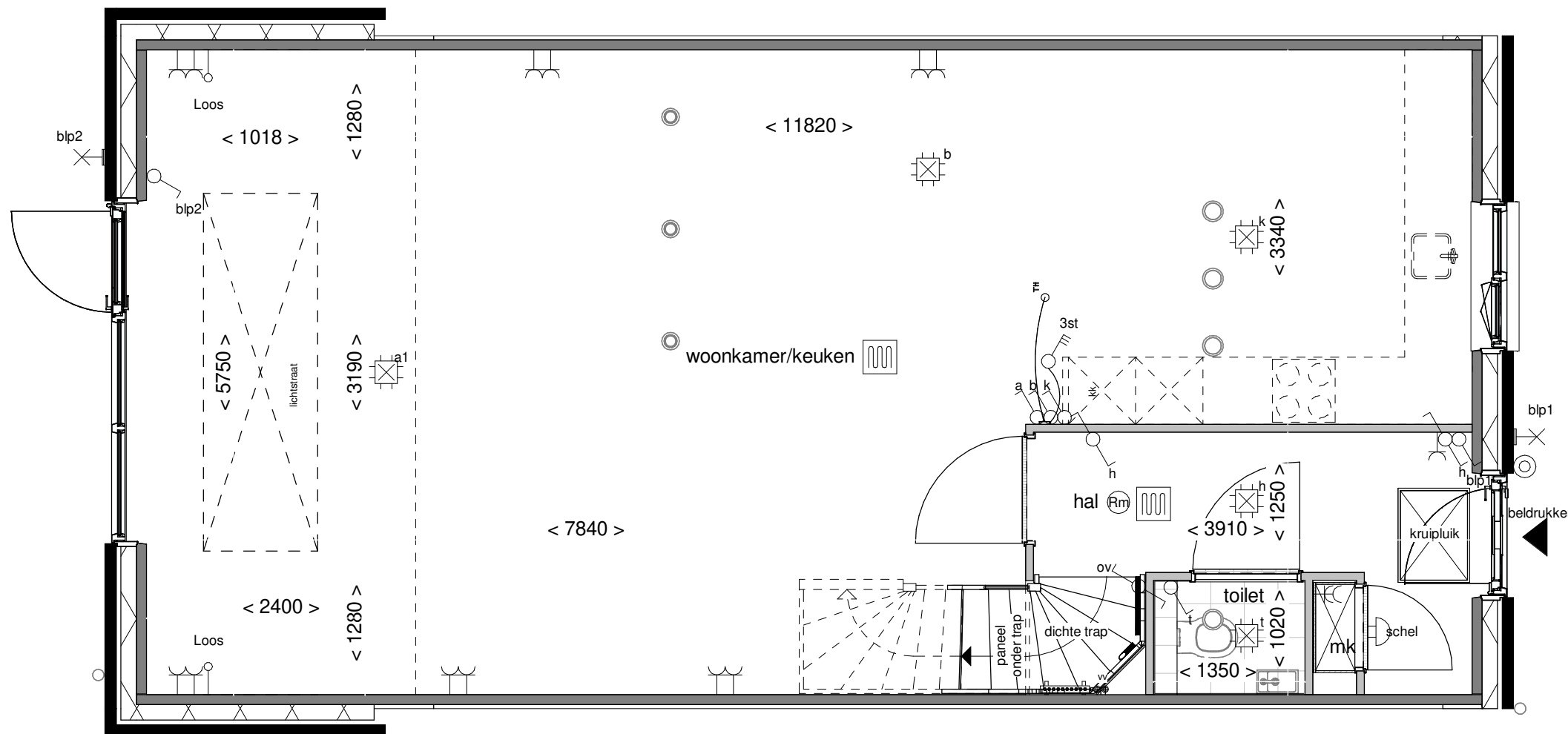

Doorsnede schaal 1:100



Optie: Lichtstraat in uitbouw
240cm

Woningtype: C60

Bouwnummer: -

Optienummer: 1.B.X.14

Schaal: 1:50 / 1:100

Datum: 18-04-2023

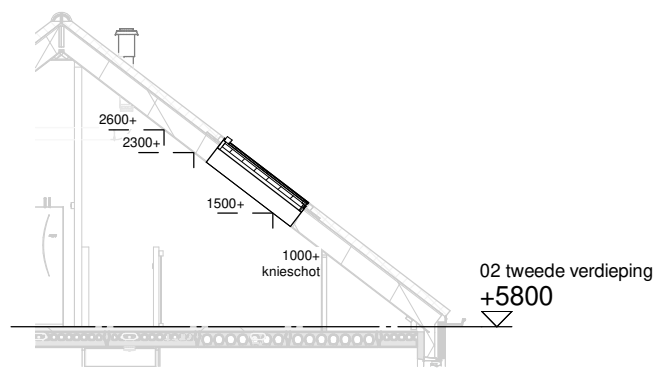
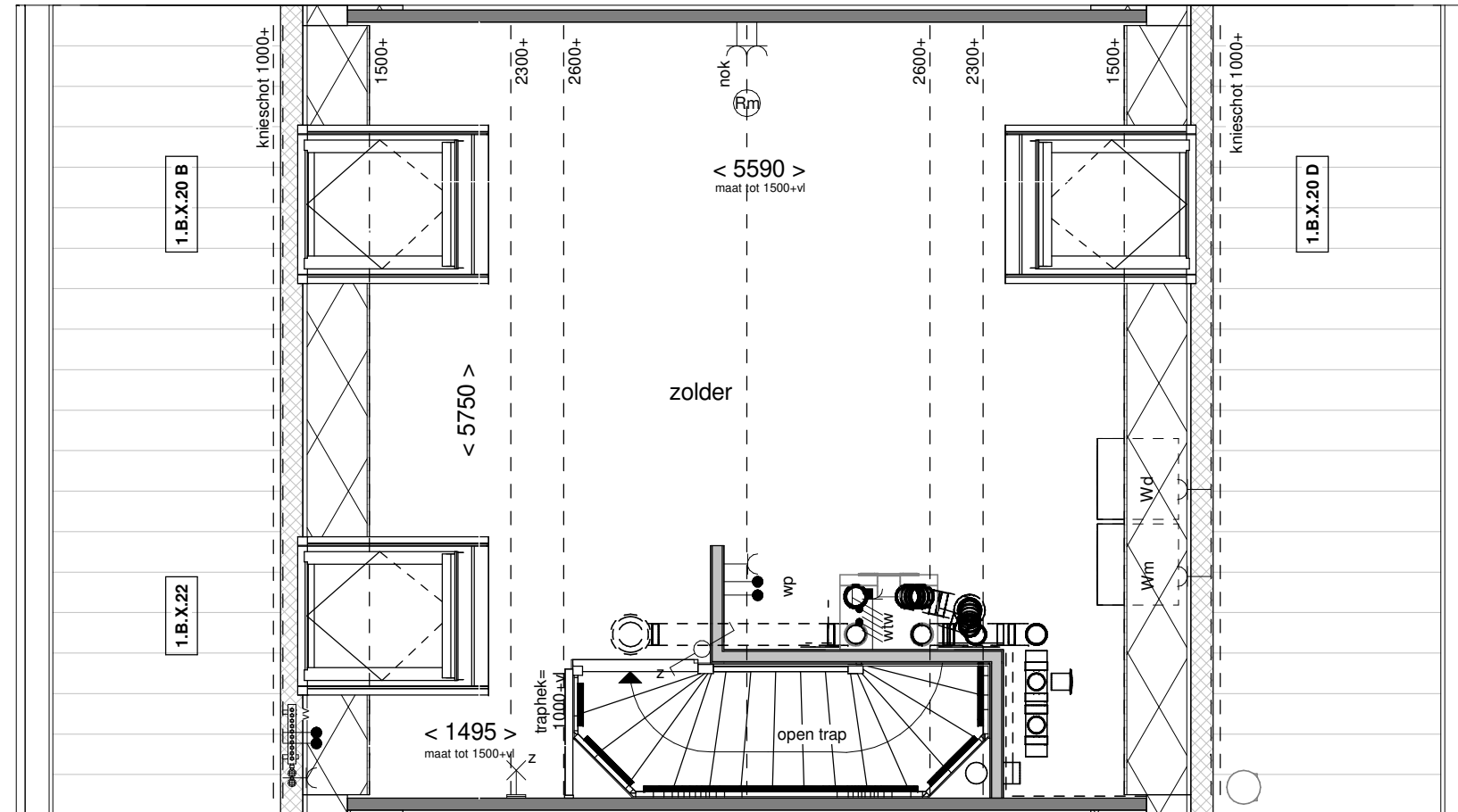

Doorsnede schaal 1:100



Achtergevel schaal 1:100

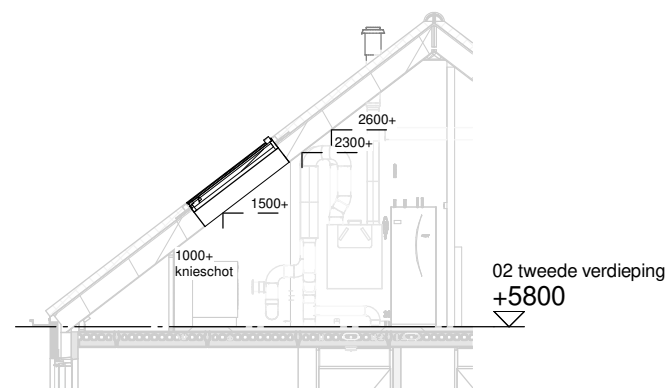

Doorsnede schaal 1:100



Voorgevel schaal 1:100

**BENT
WIJCK**
BENTHUIZEN

Optie: Dakramen voor- en achtergevel

Woningtype: C60

Bouwnummer: -

Optienummer: 1.B.X.20 / 1.B.X.22

Schaal: 1:50 / 1:100

Datum: 18-04-2023

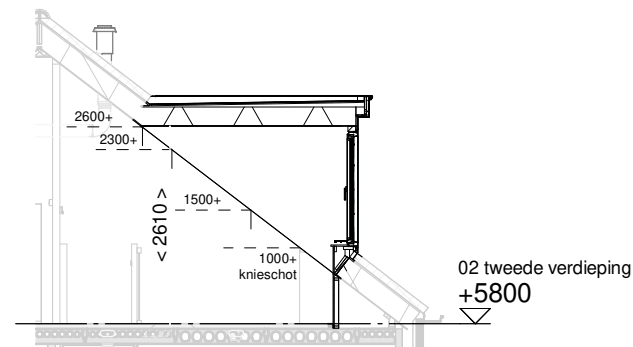
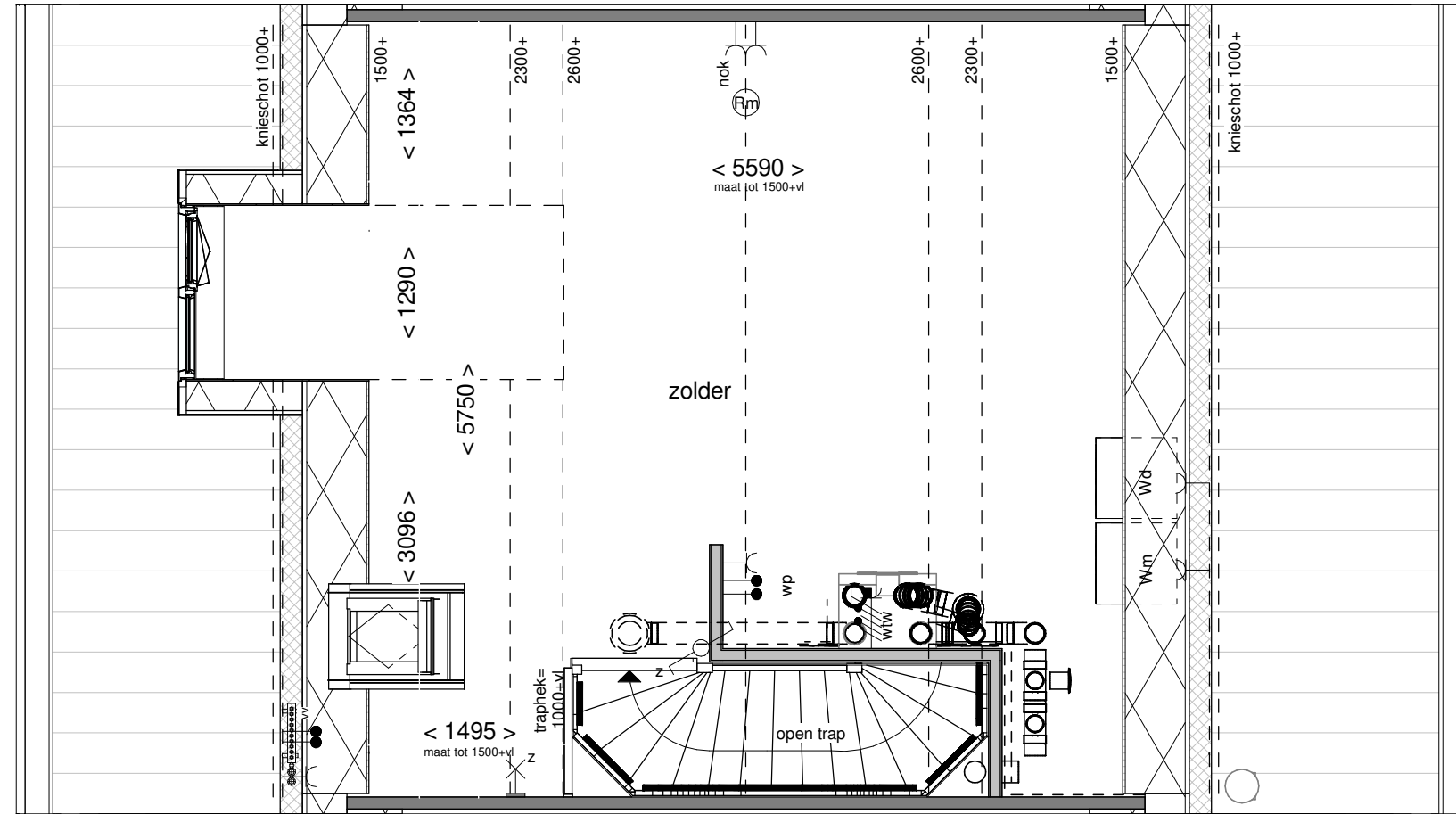

Doorsnede schaal 1:100



Achtergevel schaal 1:100

**BENT
WIJCK**
BENTHUIZEN

Optie: Dakkapel
achtergevel 130cm

Woningtype: C60

Bouwnummer: -

Optienummer: 1.B.X.32A

Schaal: 1:50 / 1:100

Datum: 18-04-2023

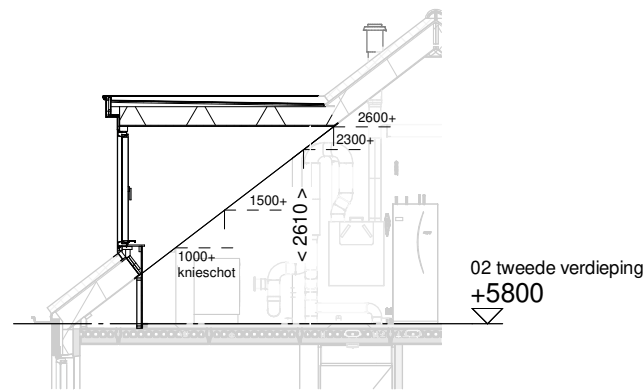
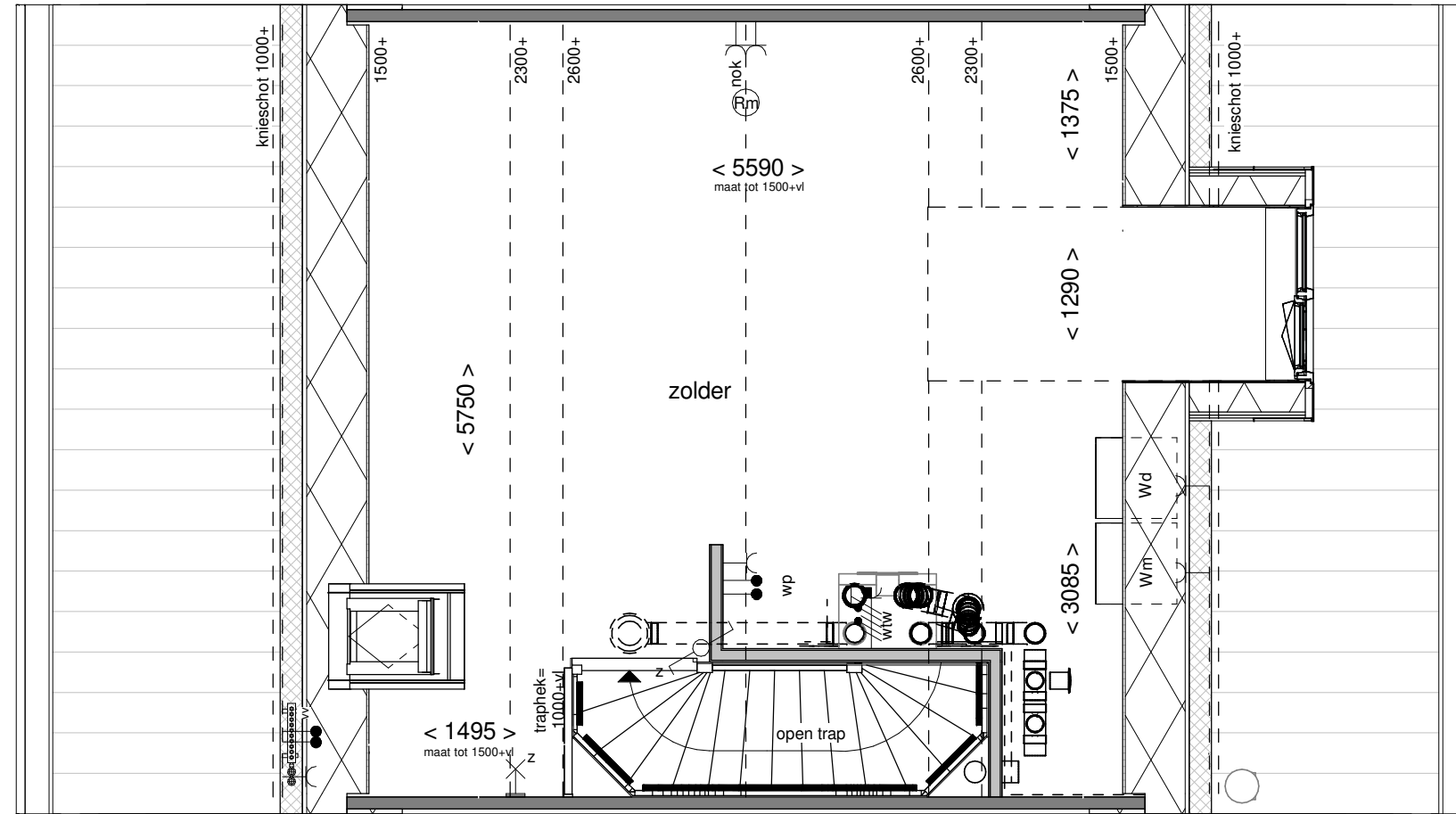

Doorsnede schaal 1:100

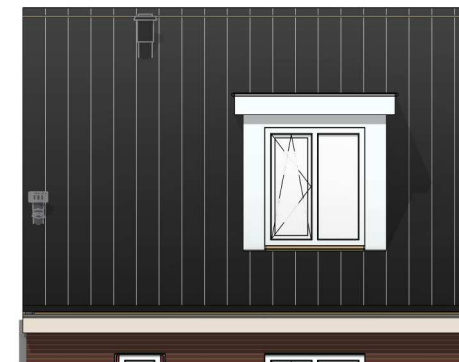

Voorgevel schaal 1:100

**BENT
WIJCK**
BENTHUIZEN

Optie: Dakkapel
voorgevel 130cm

Woningtype: C60

Bouwnummer: -

Optienummer: 1.B.X.32V

Schaal: 1:50 / 1:100

Datum: 18-04-2023

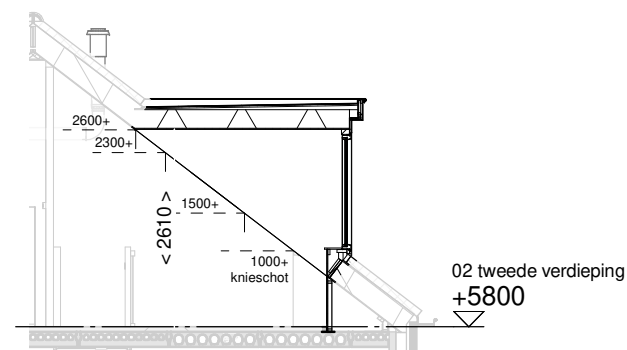
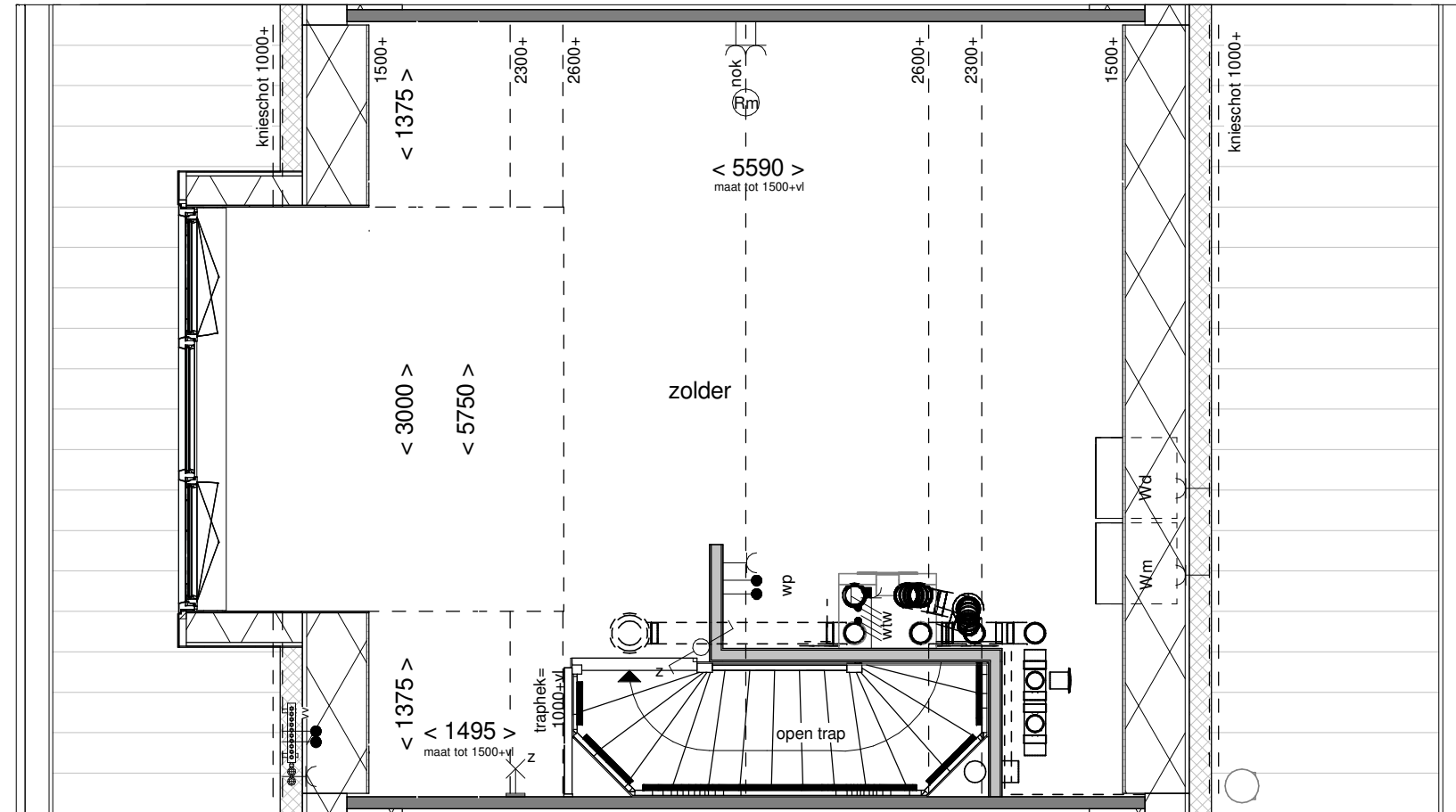

Achtergevel schaal 1:100

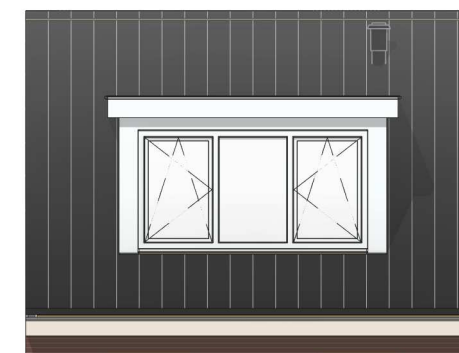

Achtergevel

**BENT
WIJCK**
BENTHUIZEN

Optie: Dakkapel
achtergevel 300cm

Woningtype: C60

Bouwnummer: -

Optienummer: 1.B.X.34A

Schaal: 1:50 / 1:100

Datum: 18-04-2023

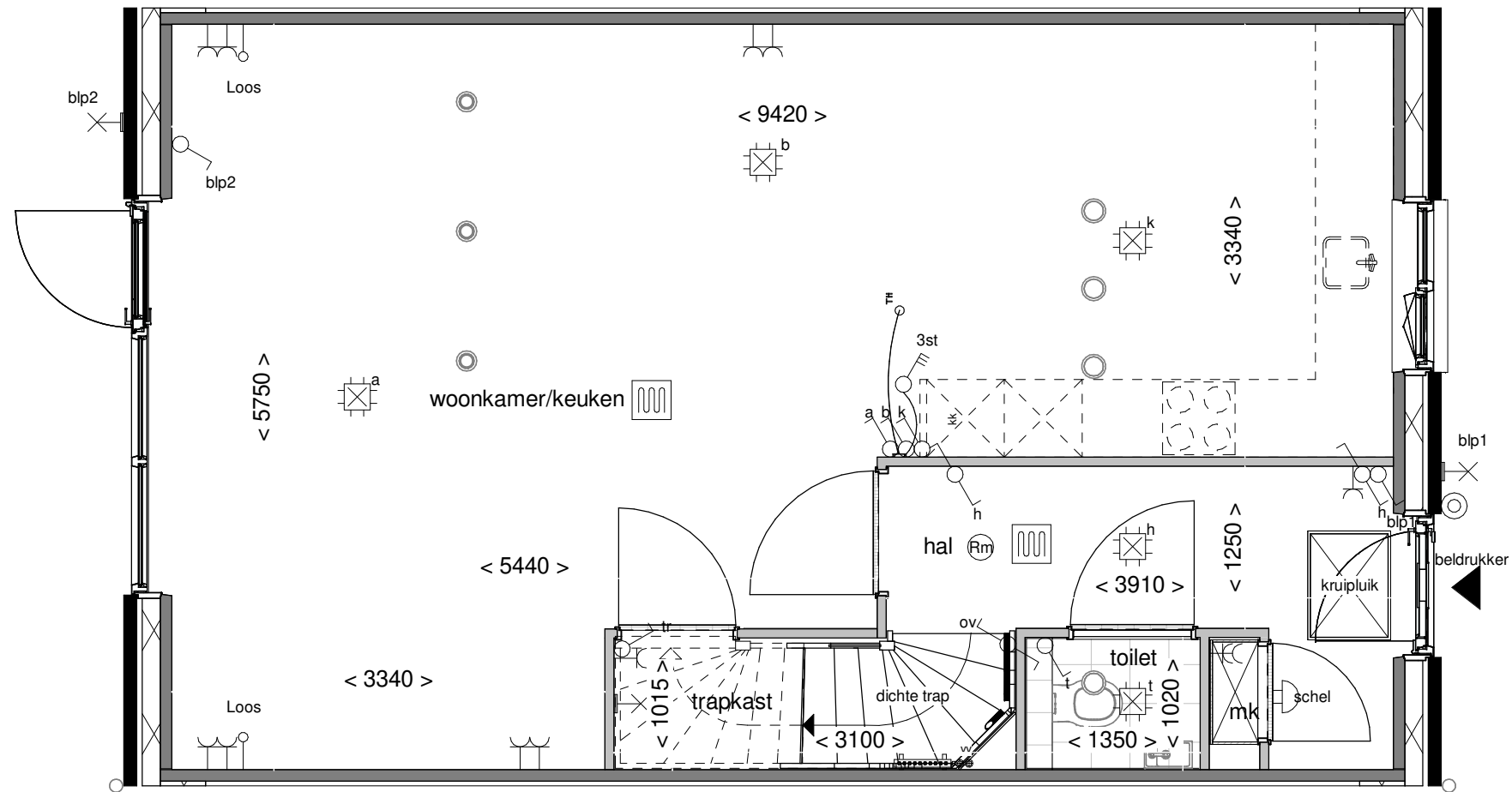

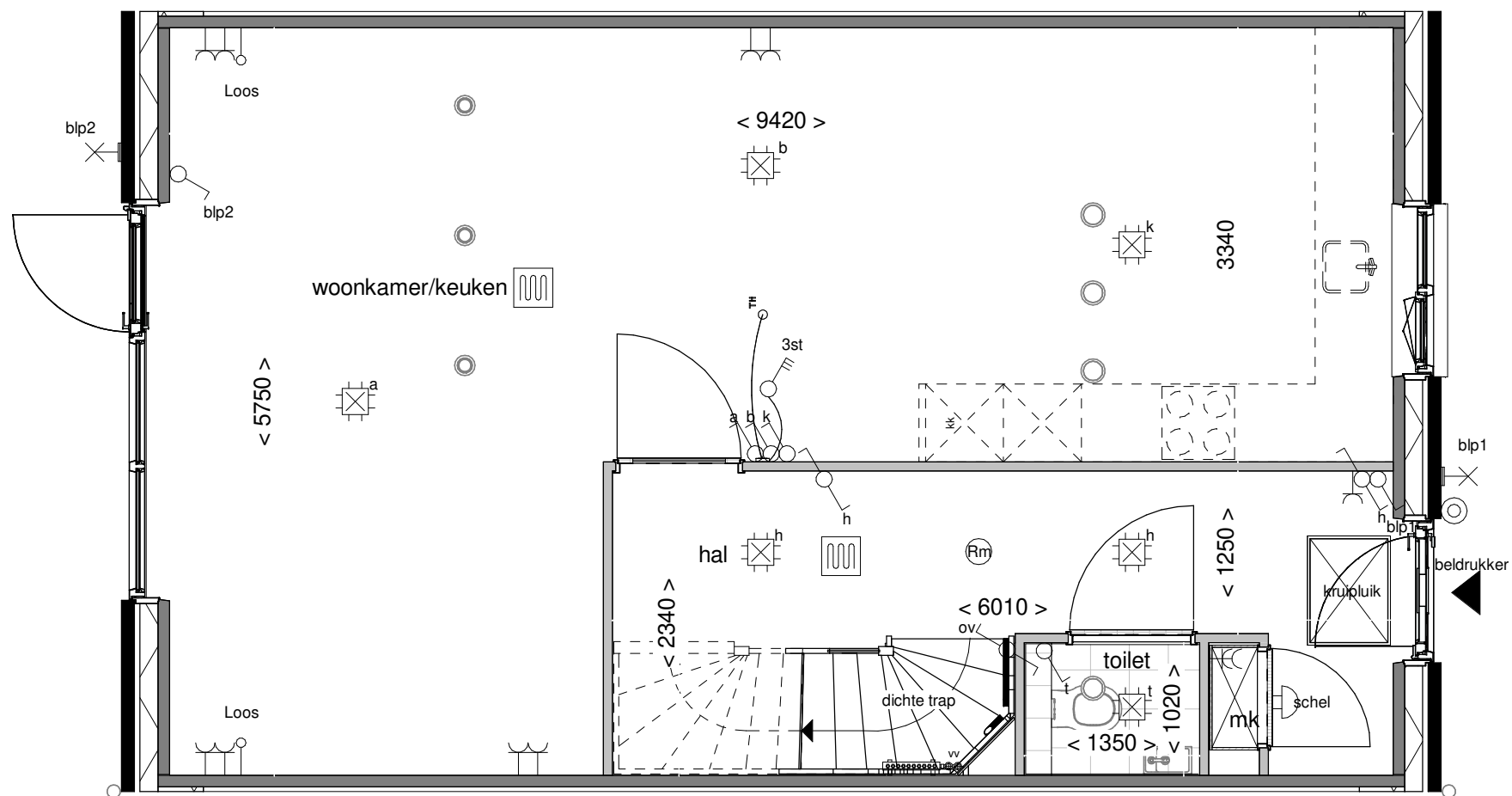

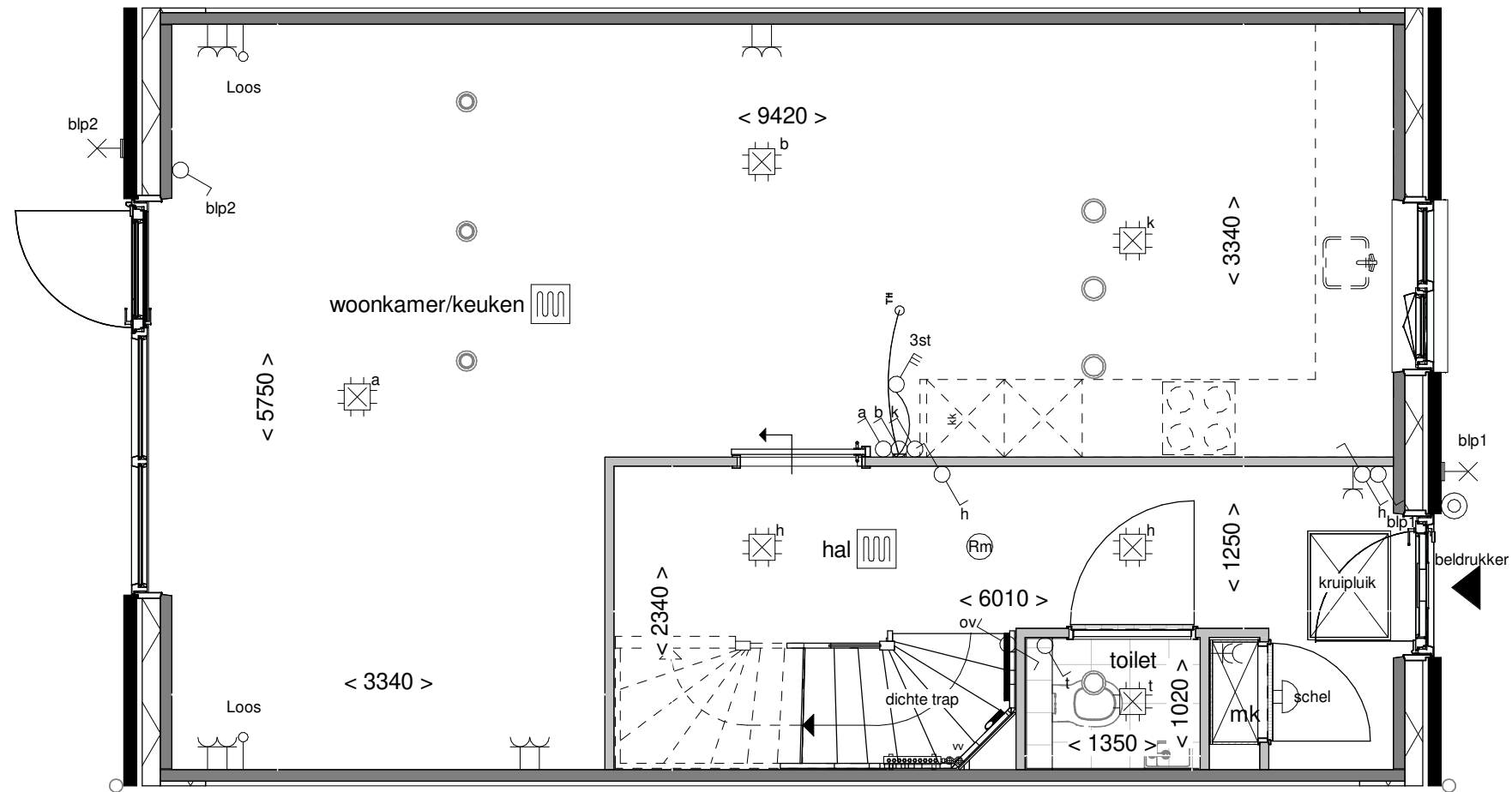

Optie: **Schuifdeur voor de wand**

Woningtype: **C60**

Bouwnummer: -

Optienummer: **1.C.C.12 - 2.L.0.24**

Schaal: **1:50**

Datum: **18-04-2023**

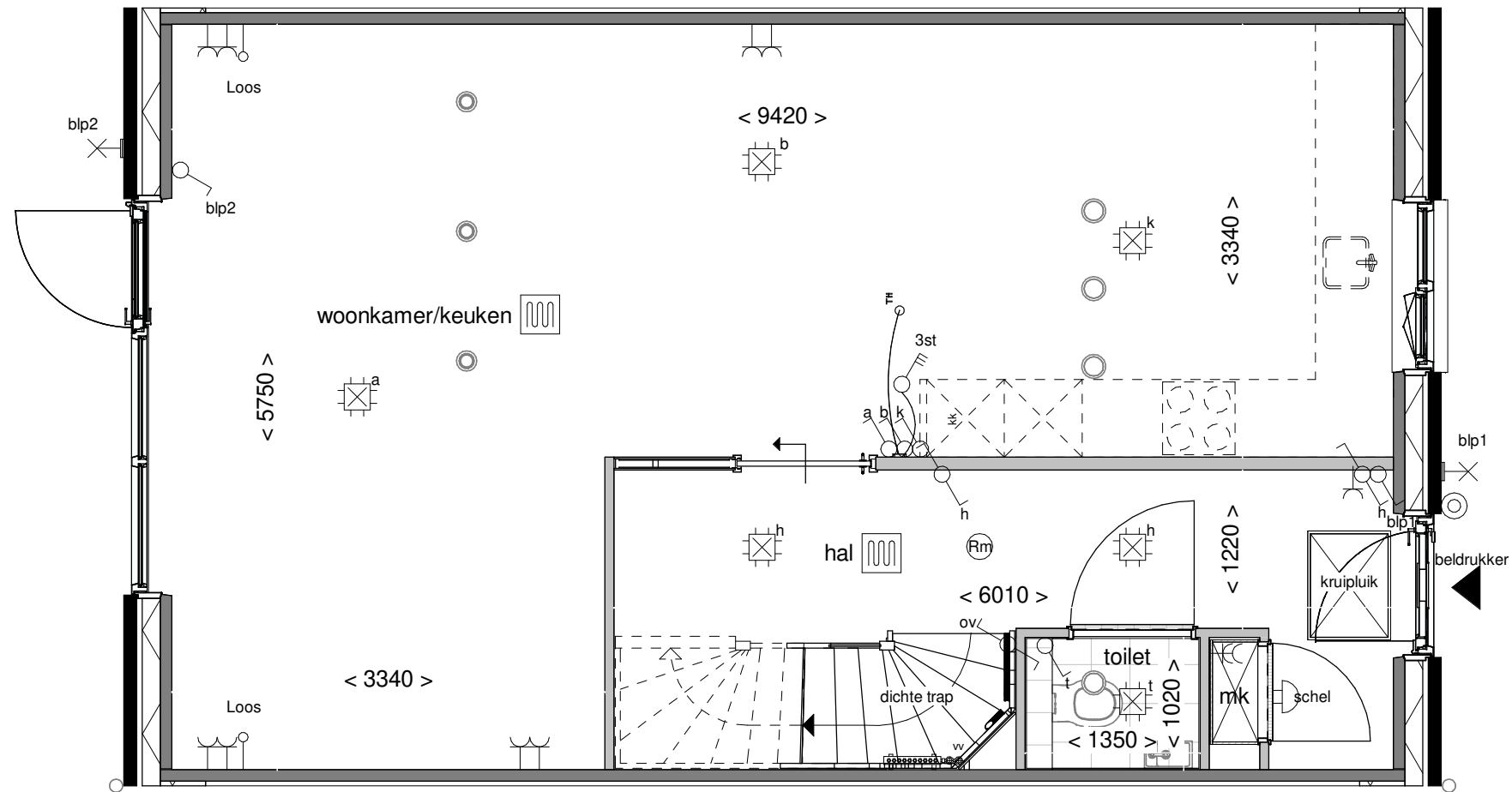

Optie: Schuifdeur in de wand

Woningtype: C60

Bouwnummer: -

Optienummer: 1.C.C.12 - 2.L.0.26

Schaal: 1:50

Datum: 18-04-2023

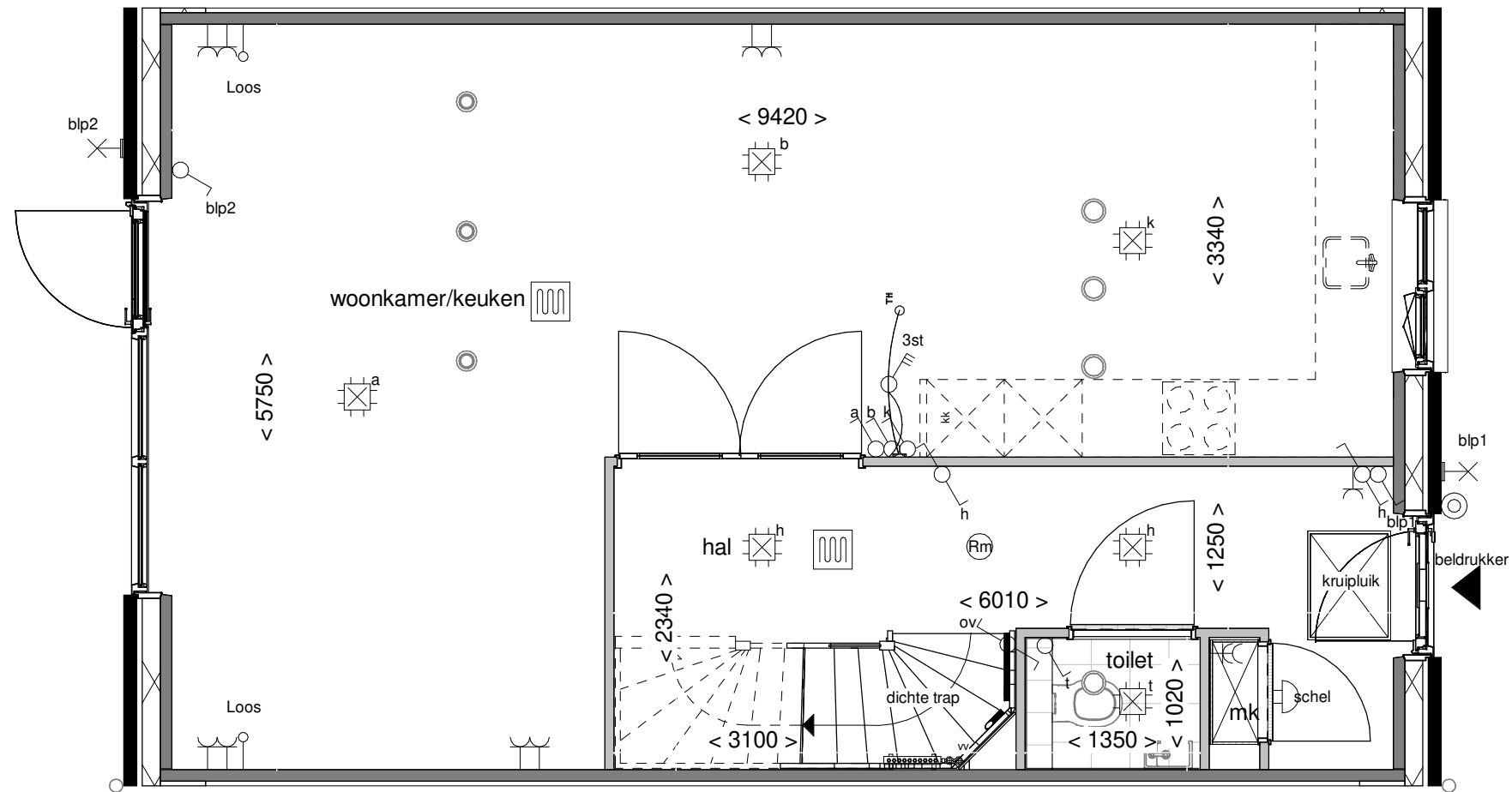

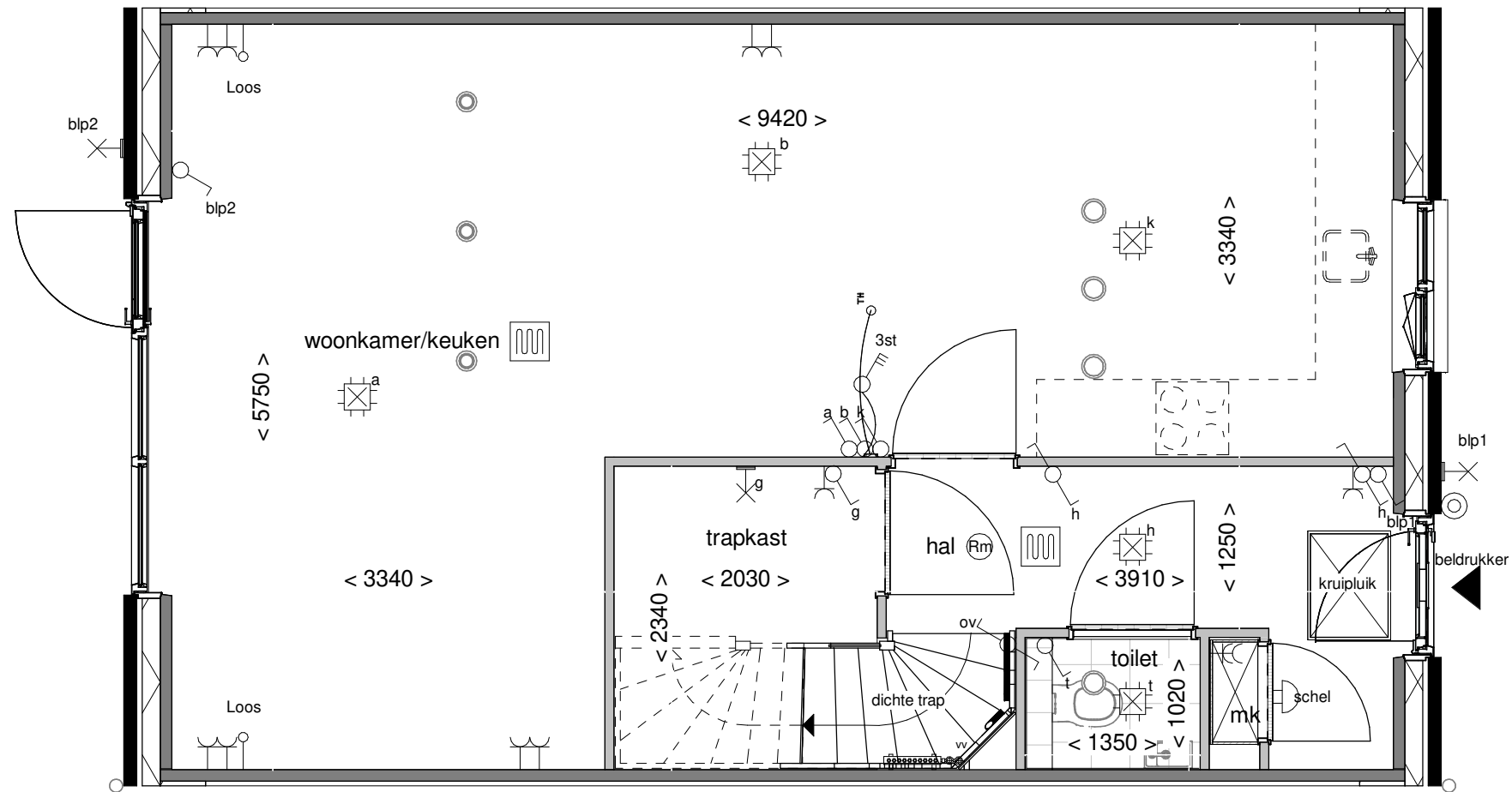

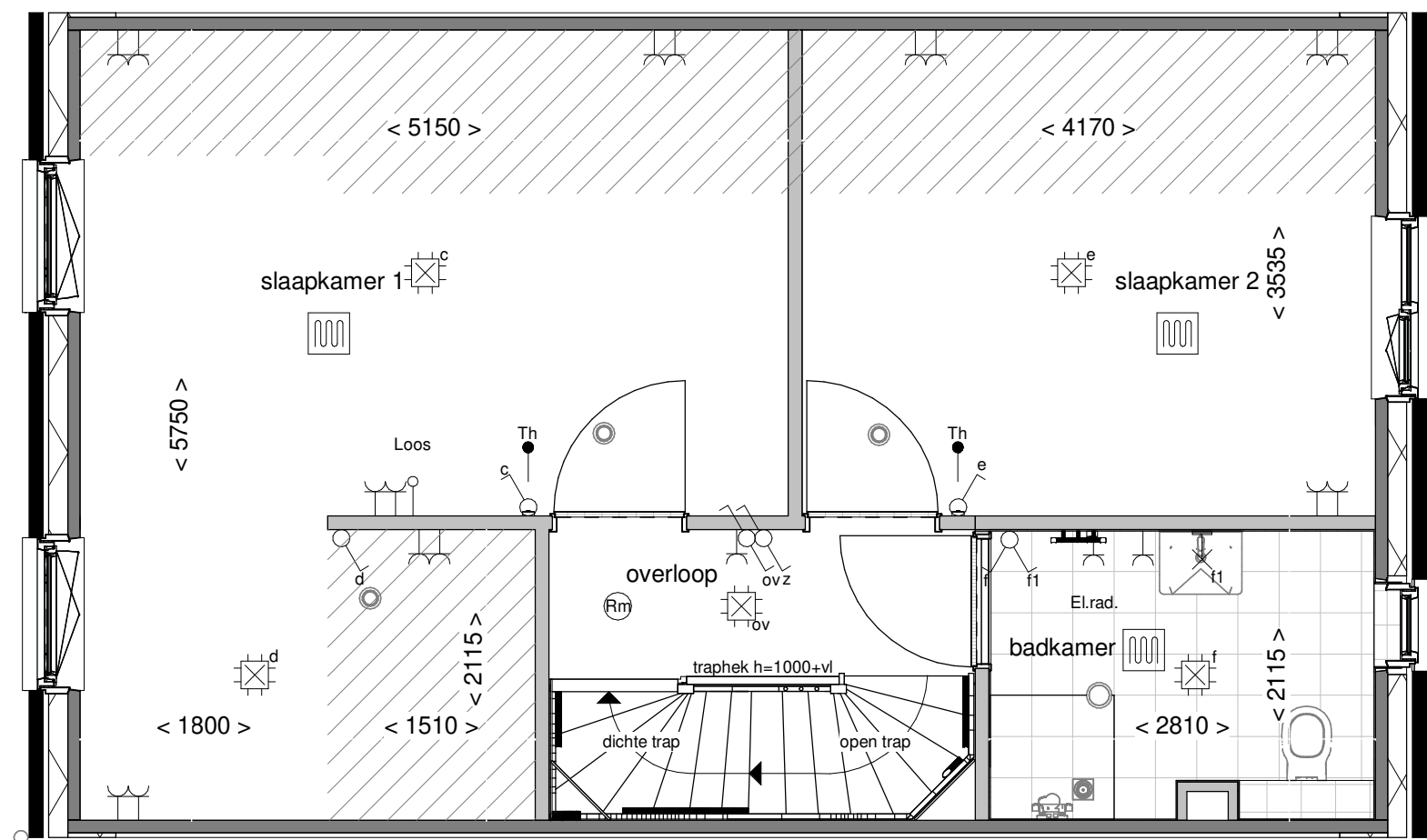

Optie: Slaapkamer 3
wijzigen in inloopkast

Woningtype: C60

Bouwnummer: -

Optienummer: 1.C.C.30

Schaal: 1:50

Datum: 18-04-2023

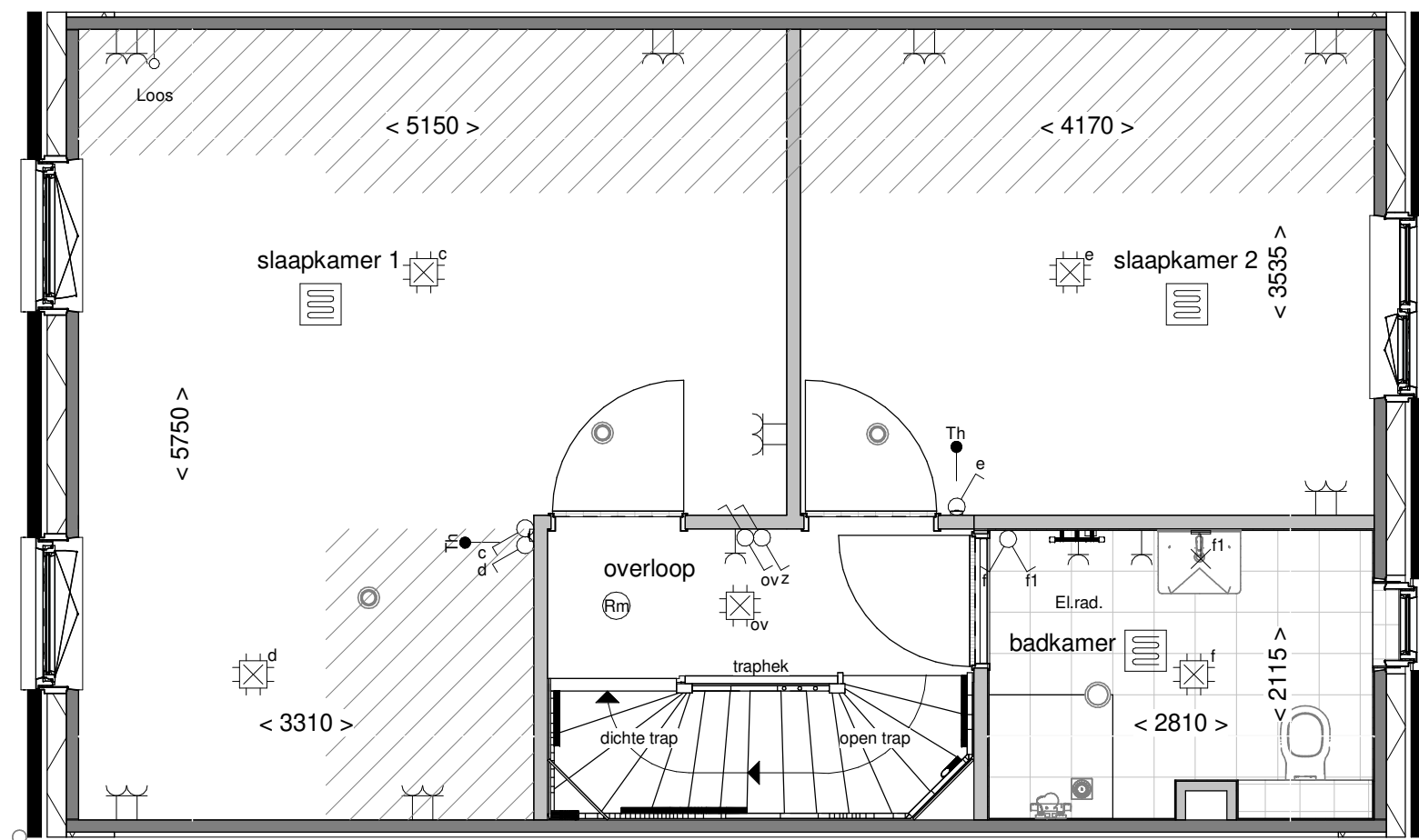

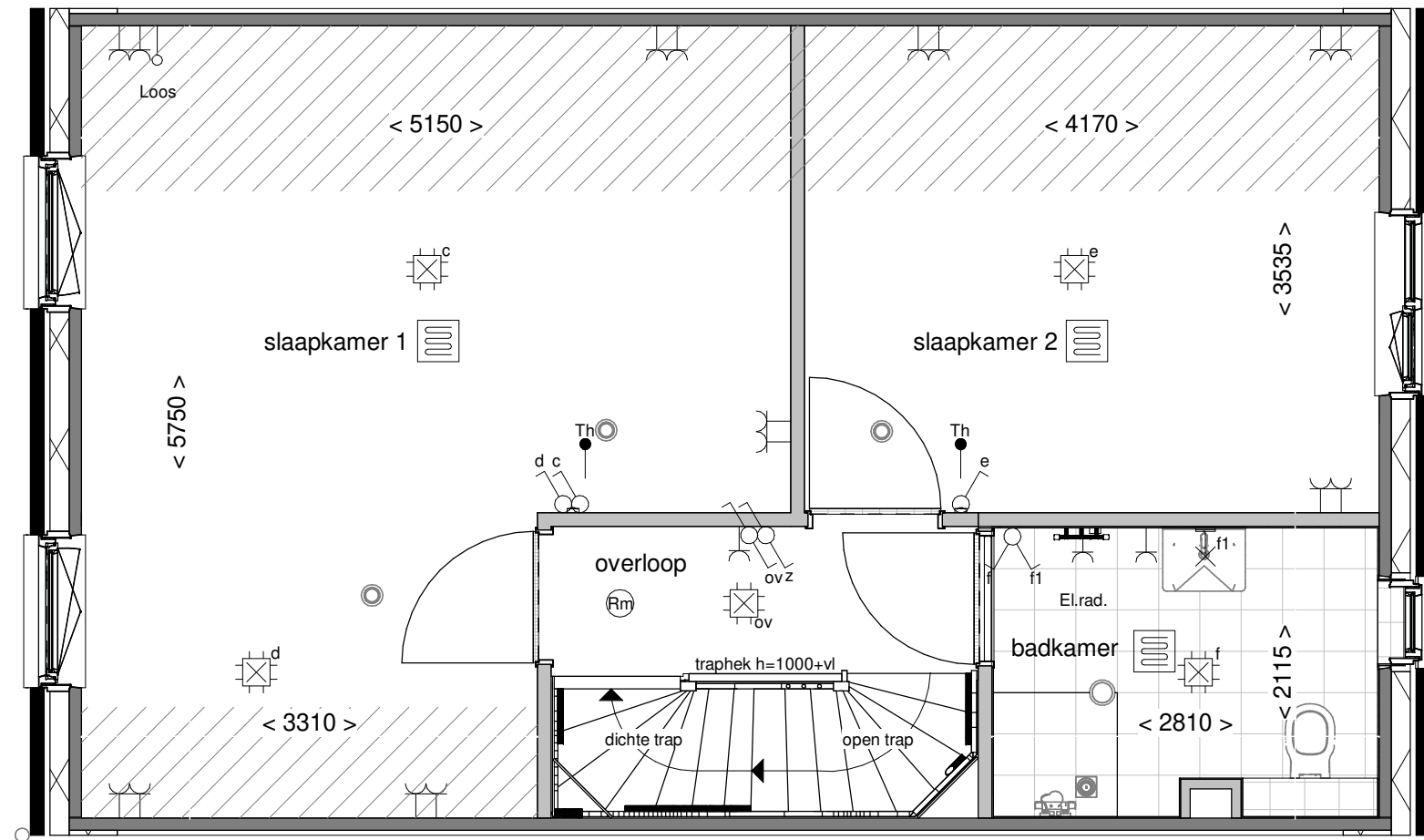

Optie: Samenvoegen
slaapk. achterzijde

Woningtype: C60

Bouwnummer: -

Optienummer: 1.C.C.33

Schaal: 1:50

Datum: 18-04-2023

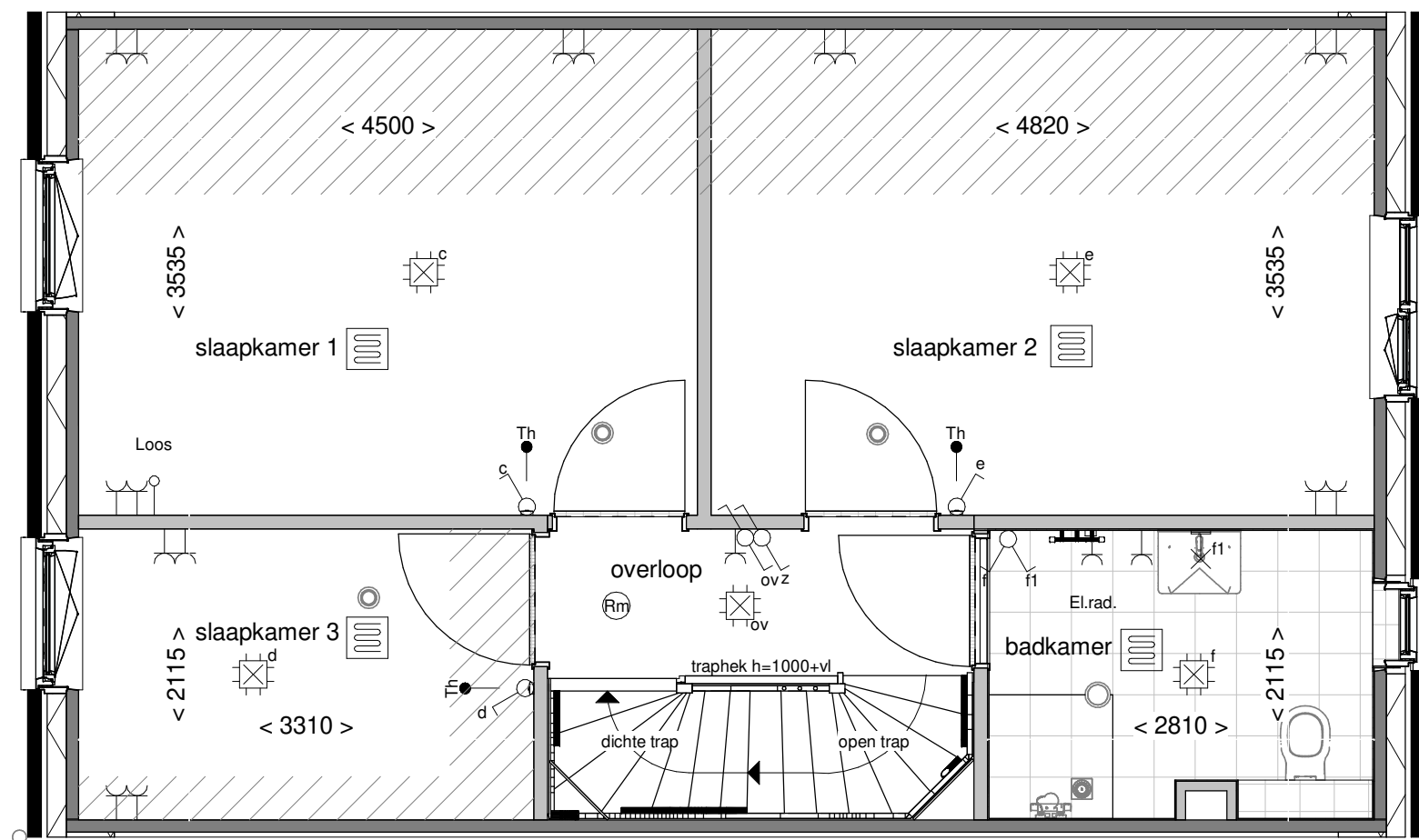

Optie: Vergroten slaapkamer 2

Woningtype: C60

Bouwnummer: -

Optienummer: 1.C.C.34

Schaal: 1:50

Datum: 18-04-2023

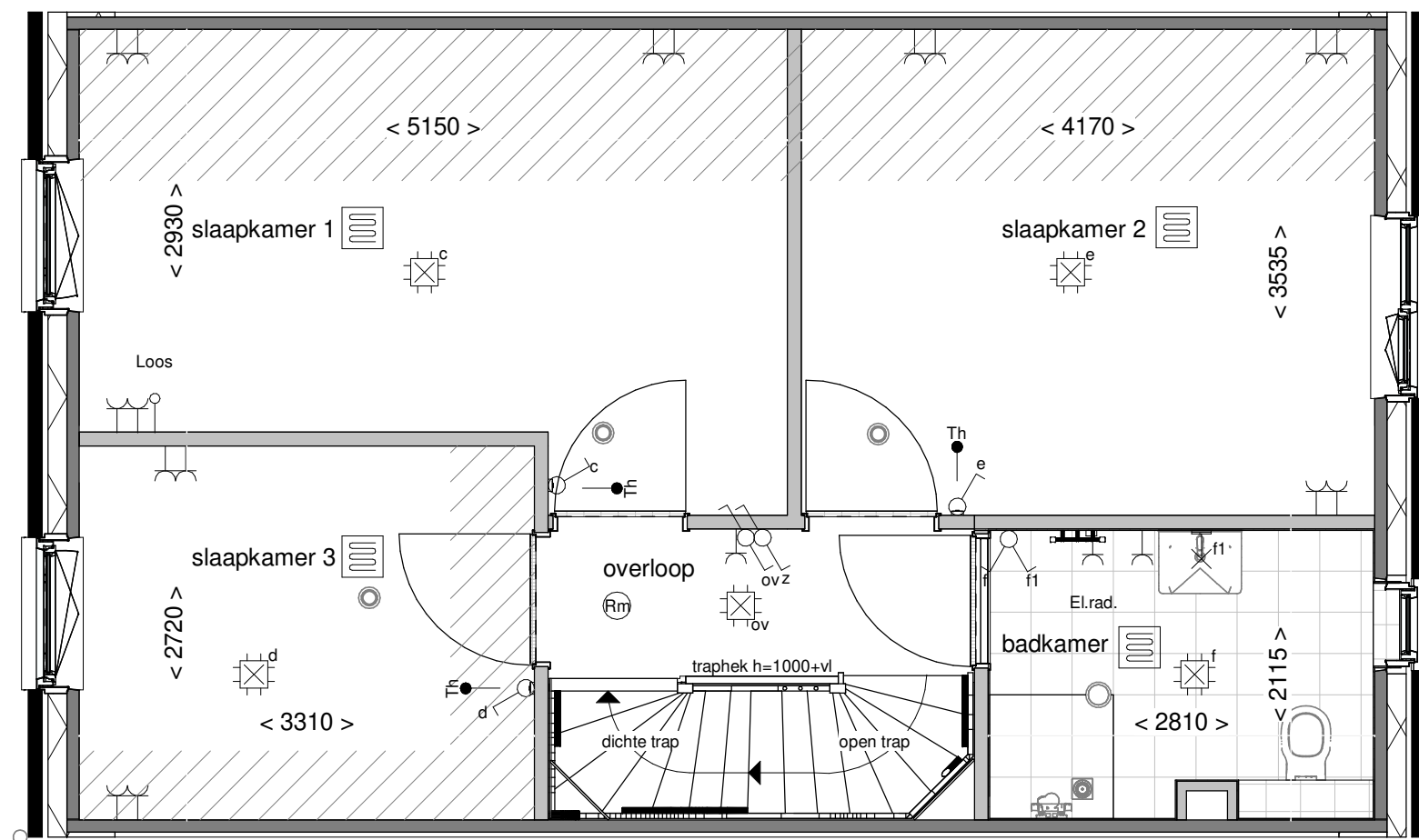

Optie: Twee ruime
kinderkamers

Woningtype: C60

Bouwnummer: -

Optienummer: 1.C.C.36

Schaal: 1:50

Datum: 18-04-2023

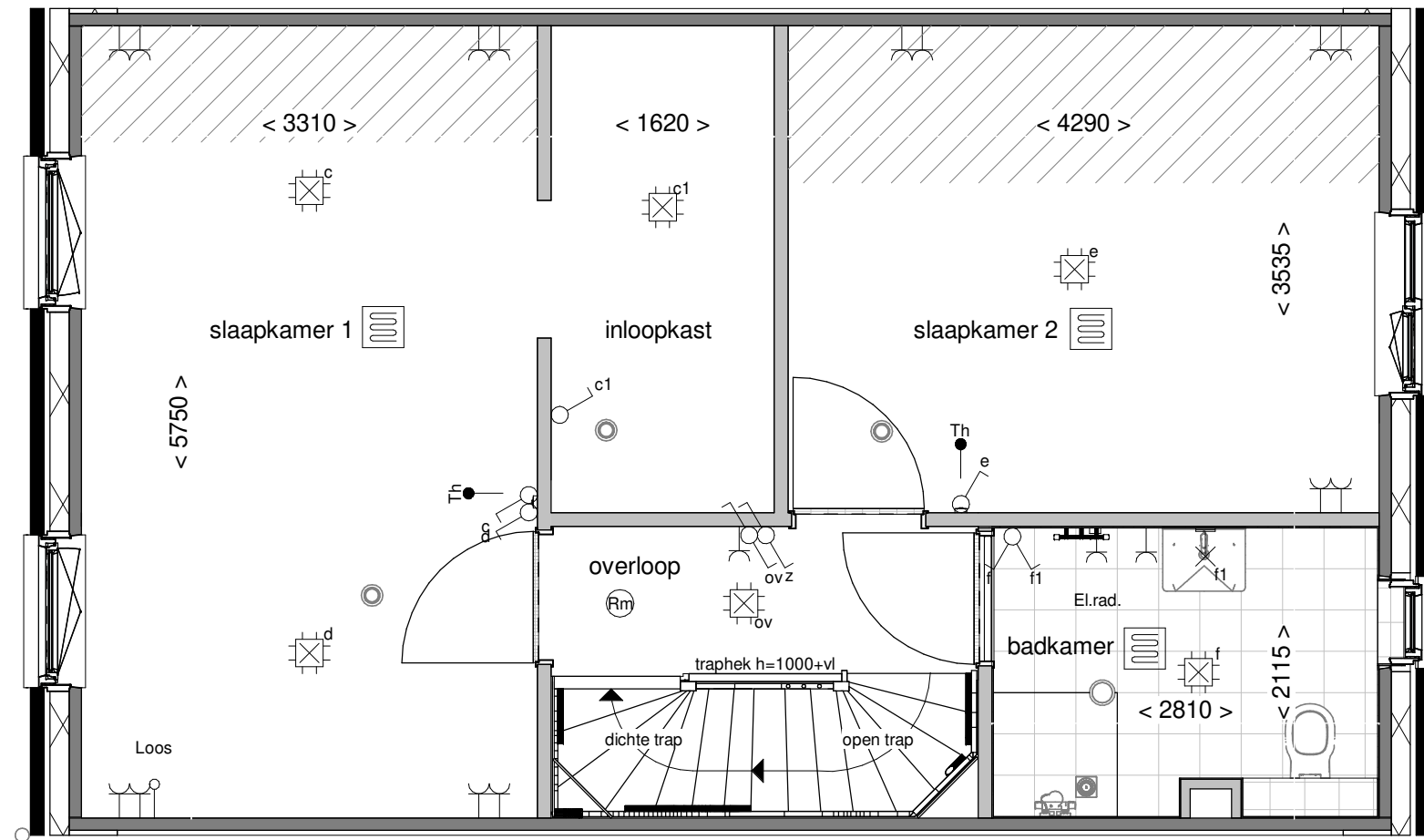

Optie: Inloopkast in slaapk. achterzijde
 Woningtype: C60
 Bouwnummer: -
 Optienummer: 1.C.C.38
 Schaal: 1:50
 Datum: 18-04-2023

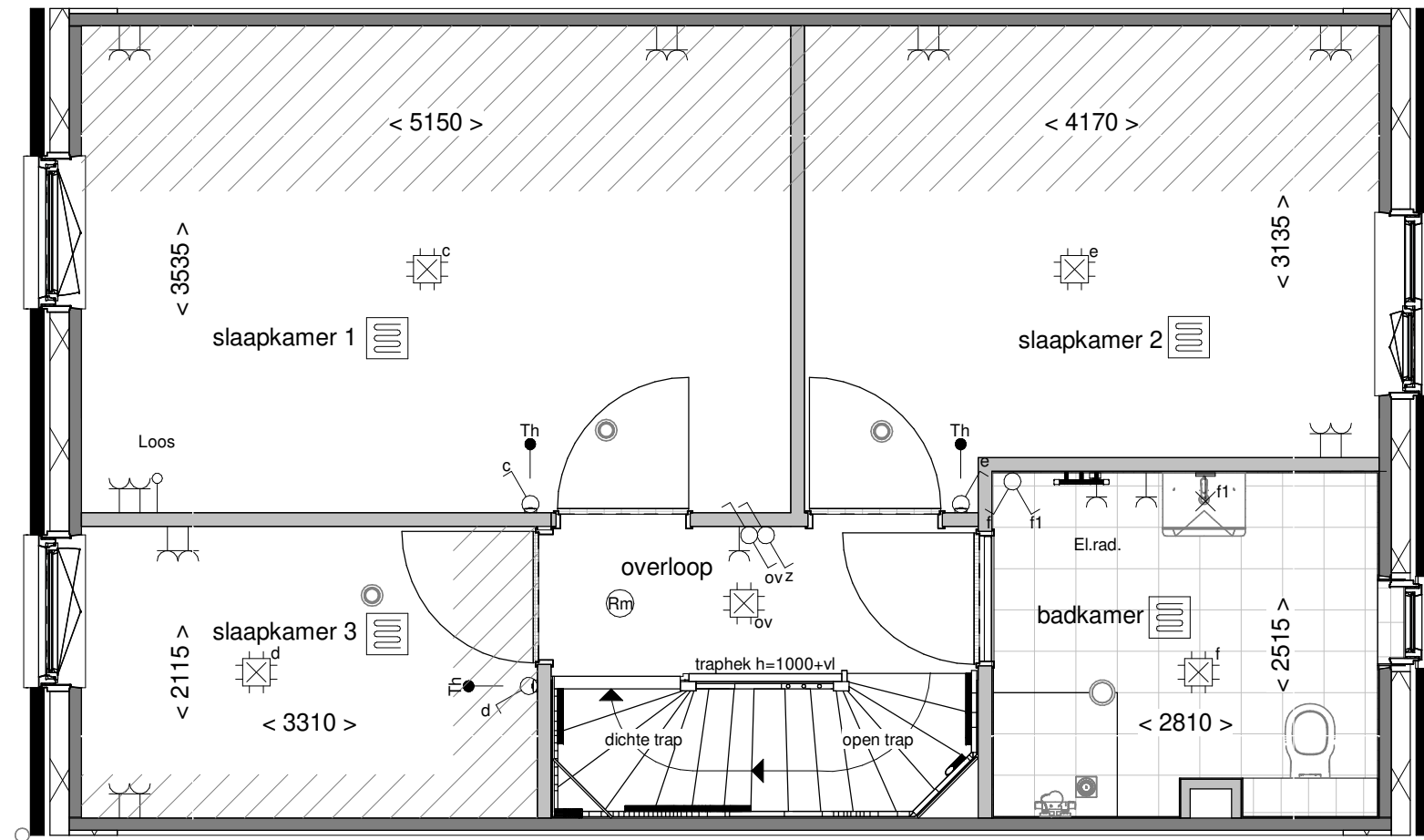

Optie: Vergroten badkamer met ca. 40cm

Woningtype: C60

Bouwnummer: -

Optienummer: 1.C.C.40

Schaal: 1:50

Datum: 18-04-2023

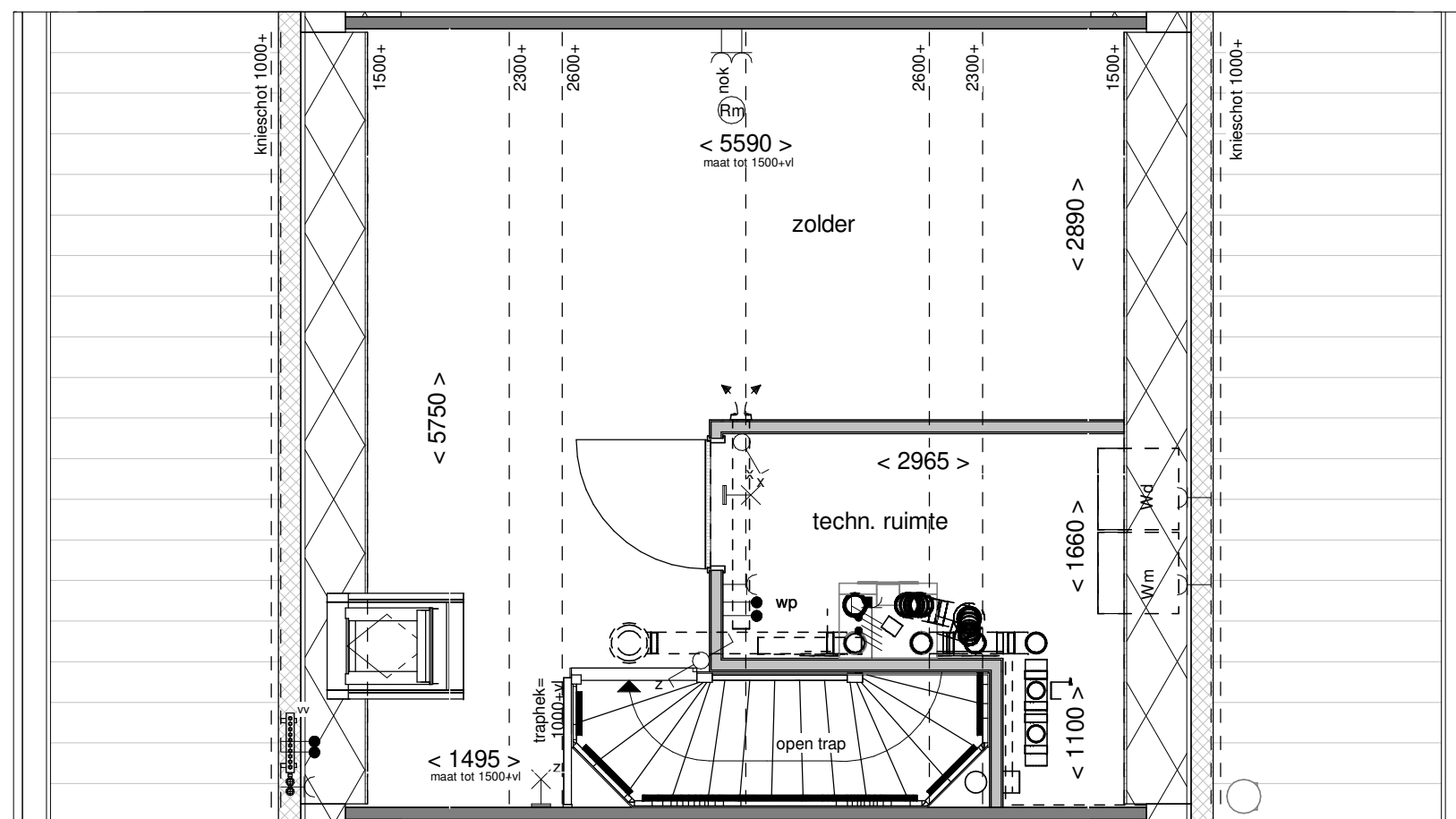

Optie: Wijzigen indeling met techniekruimte

Woningtype: C60

Bouwnummer: -

Optienummer: 1.C.C.72

Schaal: 1:50

Datum: 18-04-2023

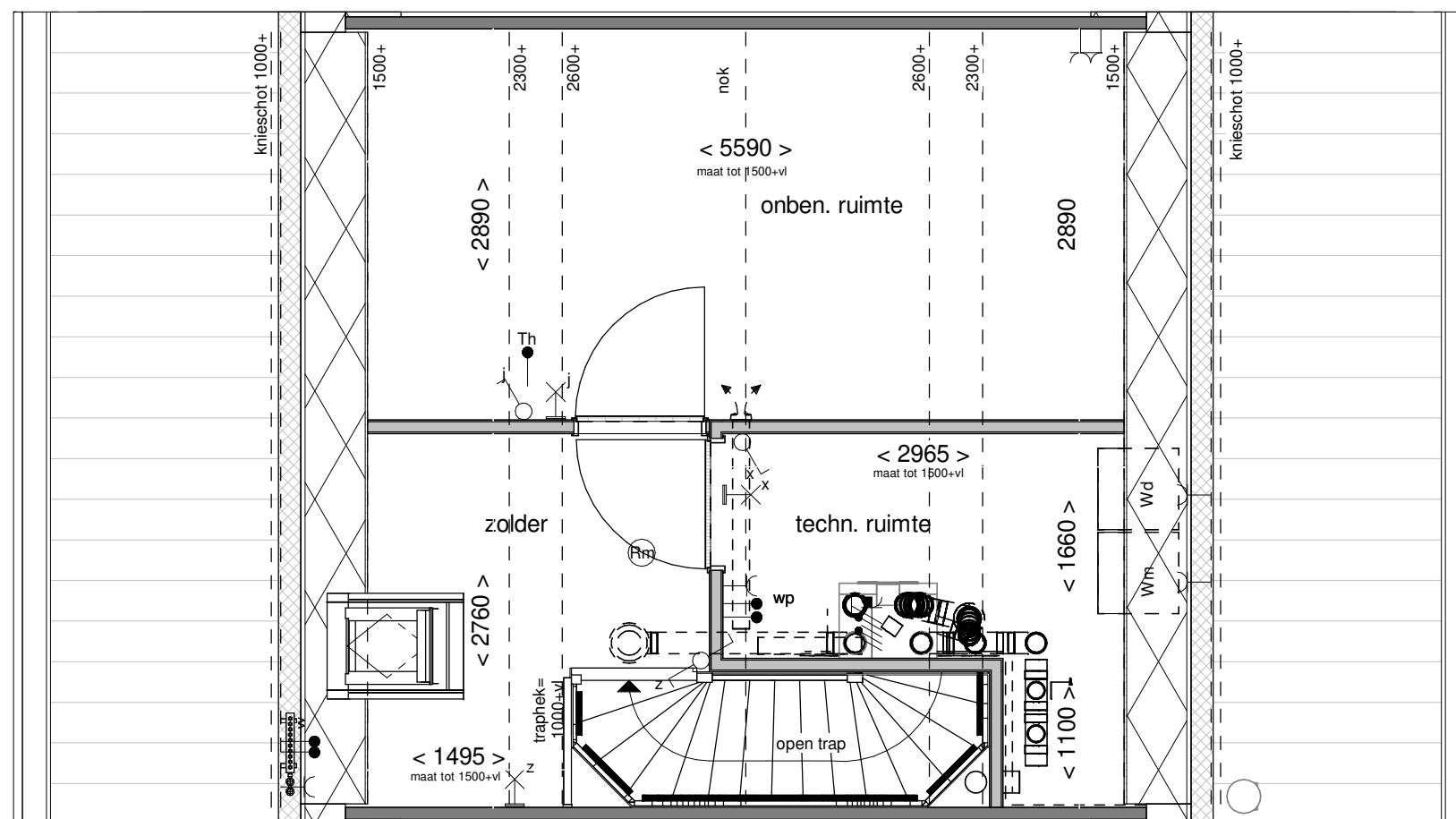

Optie: Indeling met techn.-
en onben. ruimte

Woningtype: C60

Bouwnummer: -

Optienummer: 1.C.C.74

Schaal: 1:50

Datum: 18-04-2023

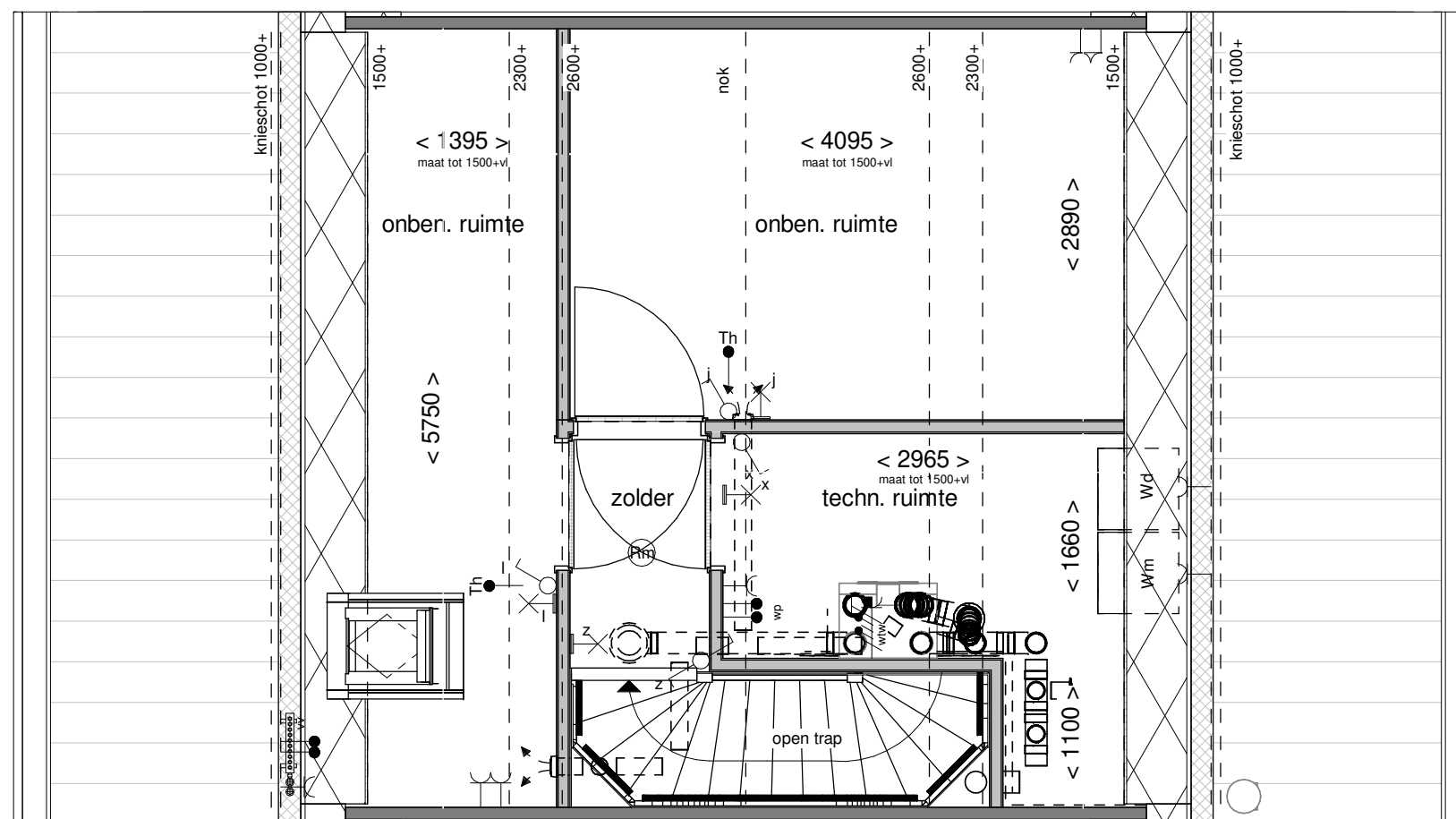

Optie: Indeling techn.- en 2 onb. ruimtes

Woningtype: C60

Bouwnummer: -

Optienummer: 1.C.C.76

Schaal: 1:50

Datum: 18-04-2023