

Renvooi

-  - entree woning
-  - erfgrans
-  - P1 parkeervak eigen terrein
-  - buitenunit warmtepomp
-  - leiding buitenunit
-  - mantelbuis t.b.v. nuts
-  - haag H=600mm
-  - schutting H=1800mm
-  - hekwerk op houten damwand
-  - schutting H=2100mm
-  - gaashek met klimplanten H=1800mm
-  - plantenrol
-  - stalen poort
-  - mandelig terrein
-  - speeltuin
-  - transformatorhuis
-  - opstelplaats vuilcontainer
-  - ondergronds containers
-  - hellingbaan
-  - talud
-  - lage houten beschoeiing

parkeerplekken en posities bomen indicatief



Tekening: **Situatie Blok 26**

Woningtype: **L72**

Bouwnummer: **106 t/m 108**

Bladnummer: **VT-26-S01**

Schaal: **1:200**

Datum: **19-12-2023**

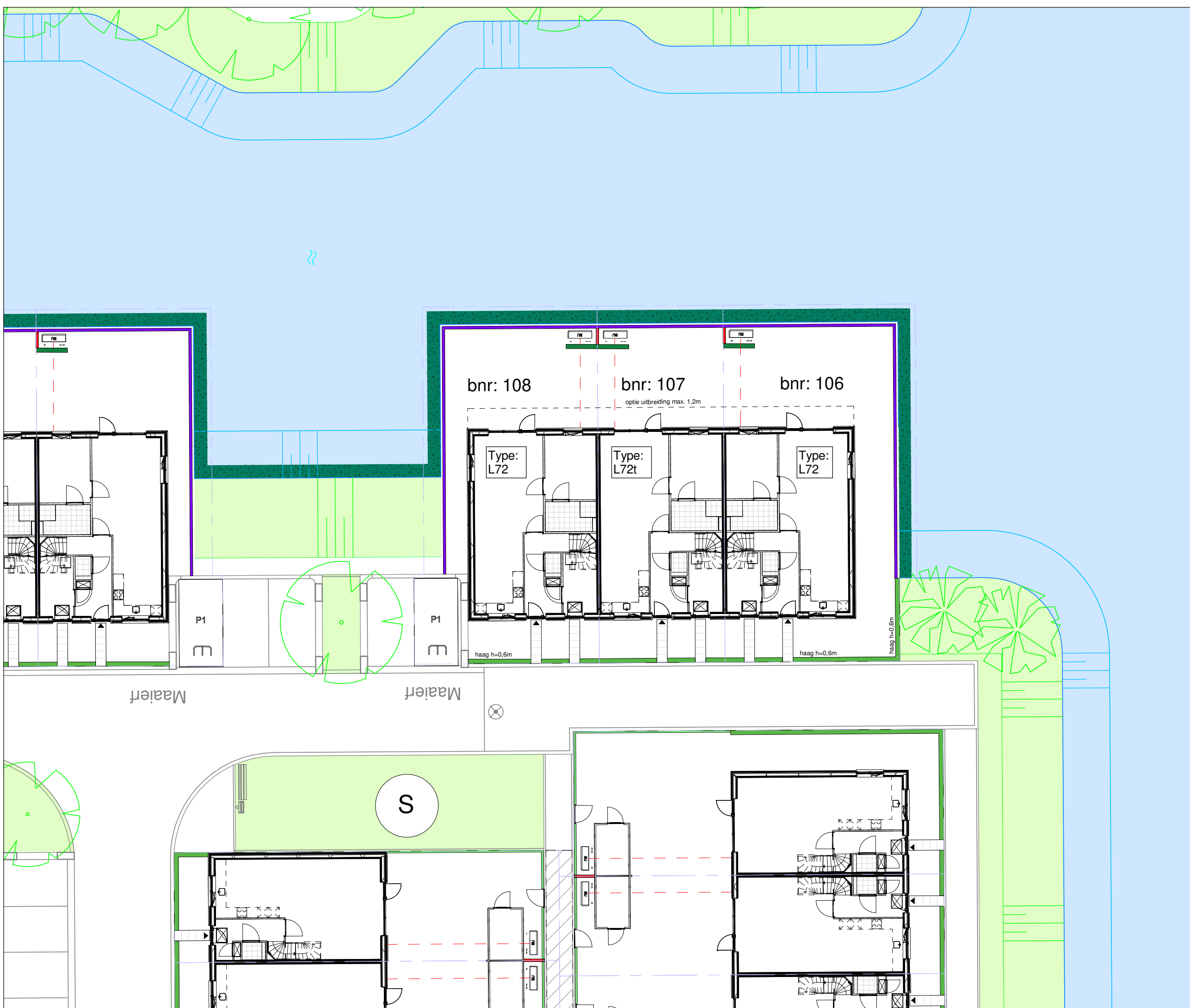

Renvooi materialen

	dakpan donkergrijs
	dakpan grijs
	dakpan rood
	metselwerk kleur rood
	metselwerk kleur bruin
	metselwerk kleur geel
	metselwerk kleur wit
	metselwerk kleur oranje
	metselwerk kleur roodbruin
	metselwerk kleur grijs
	Gevelbetimmering vezelcement, lood
	Gevelbetimmering vezelcement, roomwit

Renvooi bouwkundig

	entree woning
	metselwerk
	isolatie
	dragende wand
	niet dragende binnenwand
	binnendeurkozijn (met bovenlicht)
	kruipluik
	opstelplaats wasmachine
	opstelplaats wasdroger
	opstelplaats koelkast
	principe opstelling keukenblok (elektra conform nultekeningen Bruynzeel)
	
	onbenoemde ruimte volgens krijtstreepmethode

Renvooi installaties

	aansluitpunt licht, wand
	centraaldoos met lichtpunt
	armatuur aan de wand
	rookmelder
	aansluitpunt niet bedraad / loos
	beldrukker
	schel
	schakelaar, 1-polig
	werkschakelaar tbv PV-panelen
	driestandenschakelaar tbv wtw
	schakelaar, wissel
	schakelaar, serie
	pulsschakelaar tbv warmteterugwinunit
	wandcontactdoos 1-voudig met beschermingscontact
	wandcontactdoos 2-voudig met beschermingscontact
	thermostaatleiding, bedraad
	wandcontactdoos tbv warmteterugwinunit
	wtw mechanische ventilatie-unit incl. warmteterugwinunit
	wp warmtepomp
	inblaasventiel mechanische ventilatie
	afzuigventiel mechanische ventilatie
	wv verdeler vloerverwarming
	ruimte vzv vloerverwarming
	rad elektrische radiator
	kanalen in het zicht
	doucheput
	lijngoot douche

Disclaimer

De op deze tekeningen aangegeven maten zijn circa maten in millimeters en tussen de wanden / vloeren gemeten, waarbij geen rekening is gehouden met enige wandafwerking, plinten, aftimmering, etc. In verband met de nauwkeurige uitwerking van details, constructie, maatvoering, materialen e.d. kunnen er kleine afwijkingen ontstaan ten opzichte van de nu vermelde gegevens. Deze geringe afwijkingen geven geen aanleiding tot verrekening. Aan de op deze tekening aangegeven maten kunnen derhalve geen rechten worden ontleend. De op deze tekeningen aangegeven maatvoering is niet geschikt voor opdrachten aan derden door koper(s). De posities van aansluitingen en installatie onderdelen zijn indicatief op tekening aangegeven. De exacte aantallen en posities zullen na berekening in het werk door de installateurs worden bepaald en kunnen afwijken van deze tekening.



Tekening: Renvooi

Woningtype: -

Bouwnummer:

Bladnummer: VT-0-00c

Schaal:

Datum: 04-04-2023



Type: L72
Bouwnummer: 108

Type: L72t
Bouwnummer: 107

Type: L72
Bouwnummer: 106

Vorgevel



Type: L72
Bouwnummer: 106

Type: L72t
Bouwnummer: 107

Type: L72
Bouwnummer: 108

Achtergevel

**BENT
WIJCK**
BENTHUIZEN

Tekening: Gevels Blok 26

Woningtype: L72/L72t

Bouwnummer: 106 t/m 108

Bladnummer: VT-L26-00a

Schaal: 1:100

Datum: 18-04-2023



Type: L72
Bouwnummer: 108

Linker zijgevel



Type: L72
Bouwnummer: 106

Rechter zijgevel

 BENT
WIJCK
BENTHUIZEN

Tekening: Zijgevels Blok 26

Woningtype: L72/L72t

Bouwnummer: 106 t/m 108

Bladnummer: VT-L26-00b

Schaal: 1:100

Datum: 18-04-2023

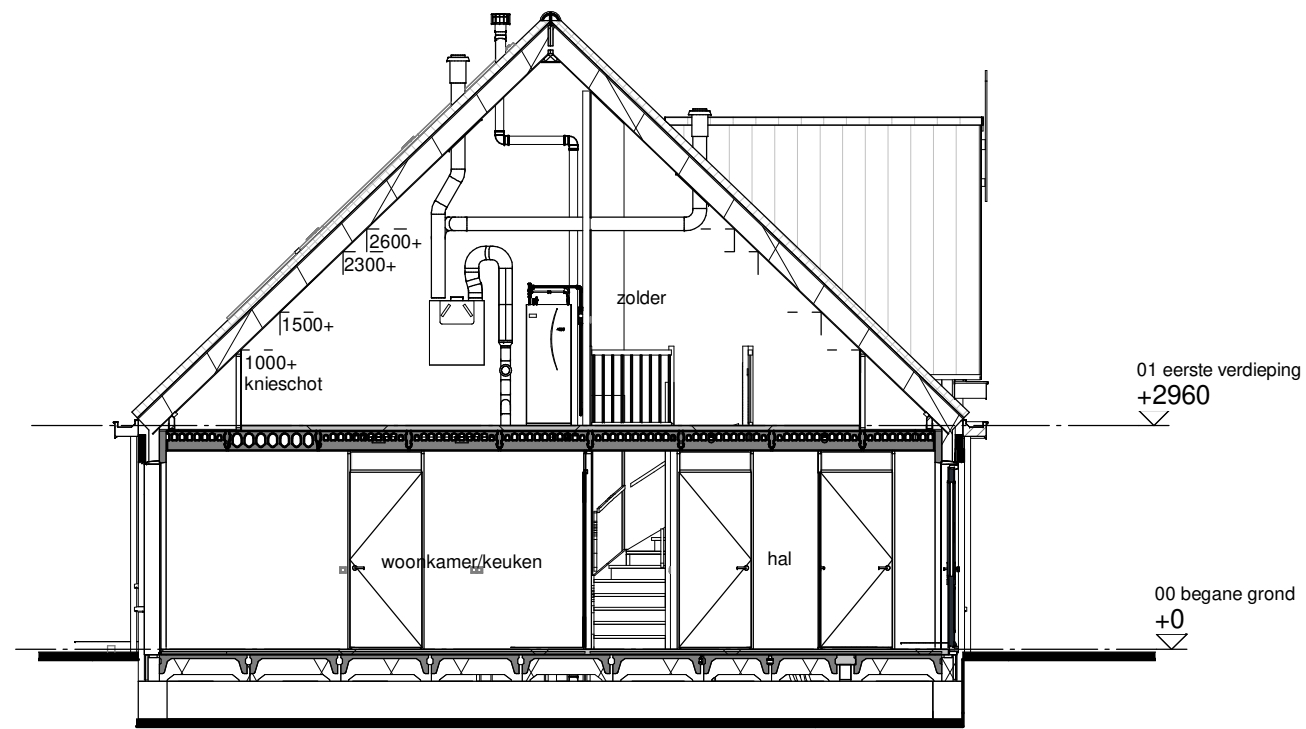

Type: L72
Bouwnummer: 108

Doorsnede A

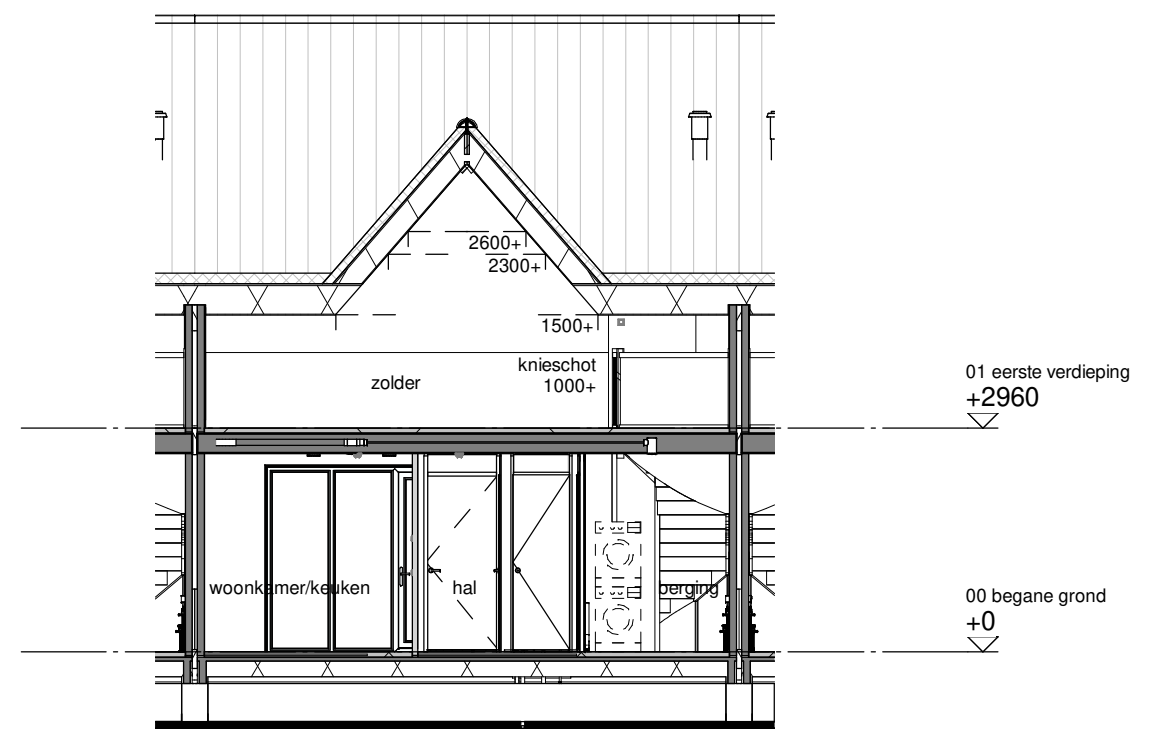

Type: L72t
Bouwnummer: 107

Doorsnede B

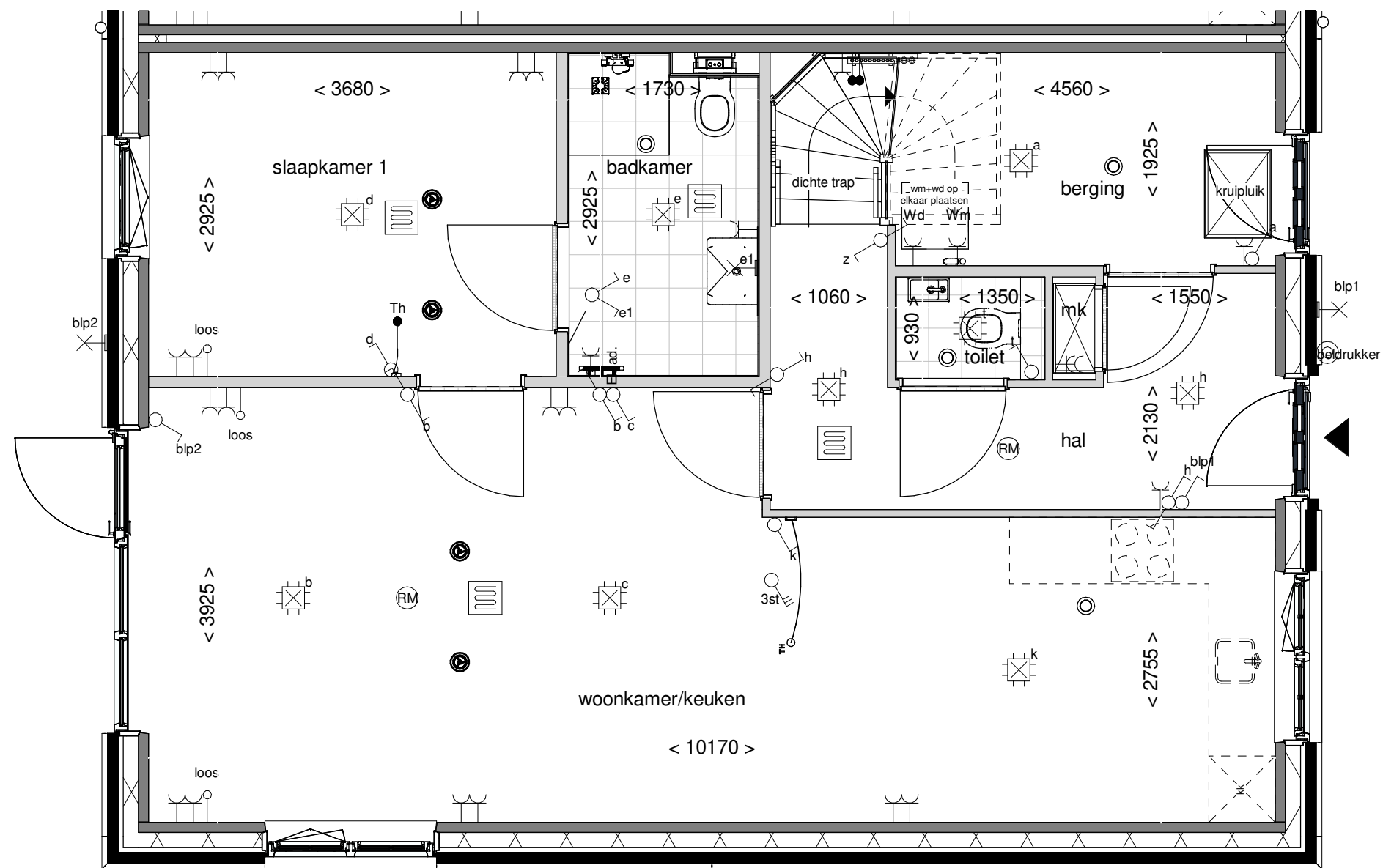

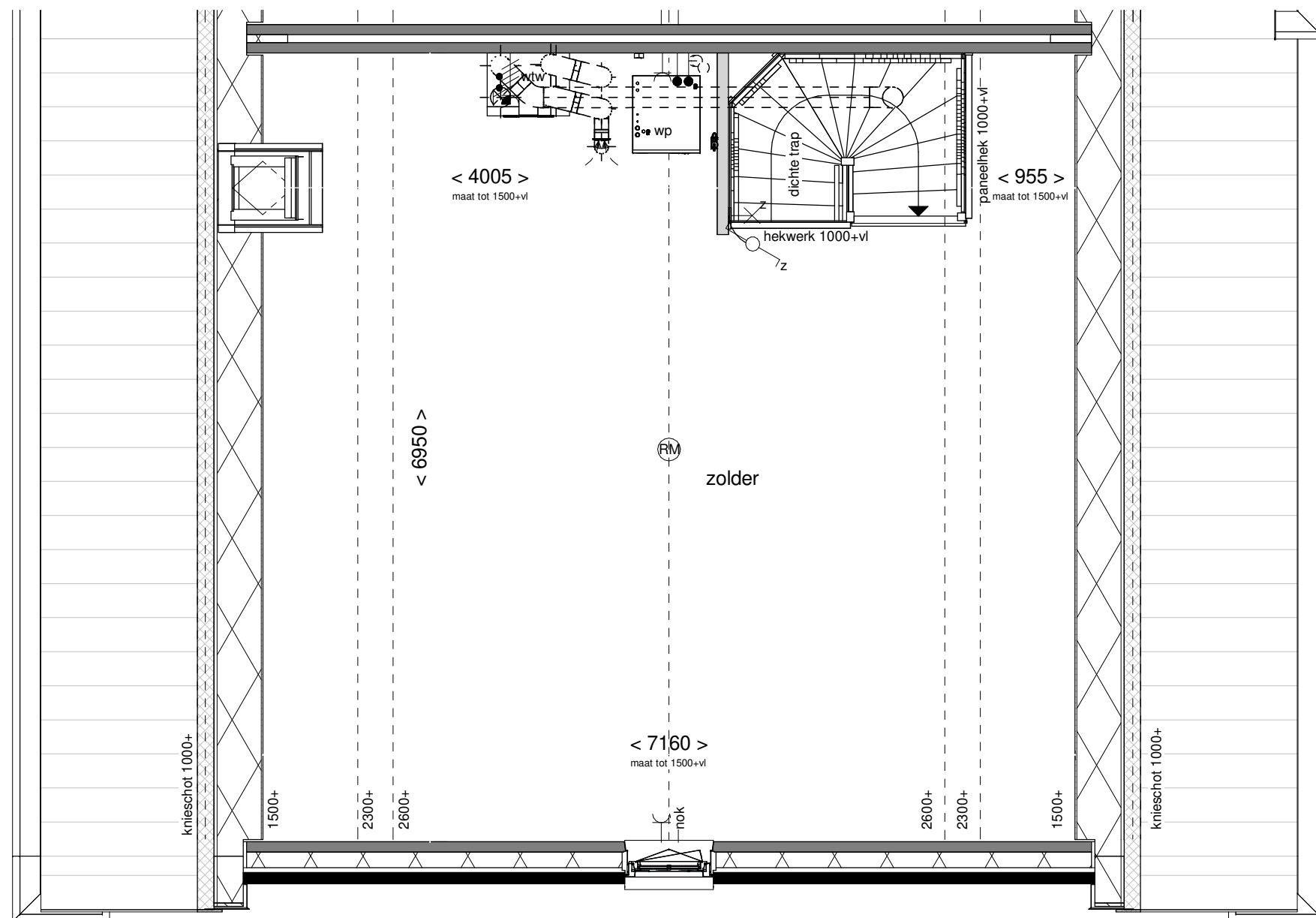

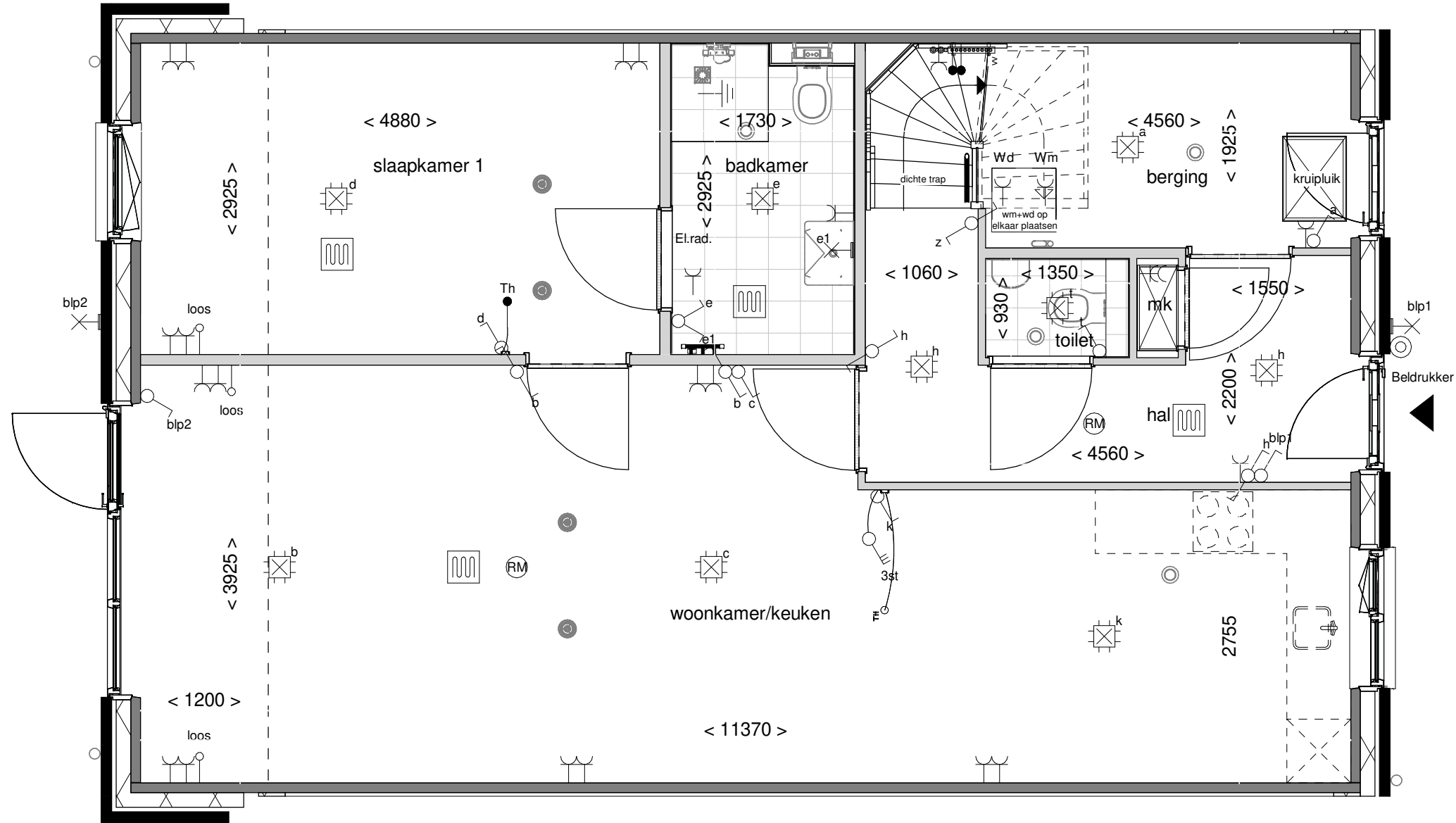

Achtergevel schaal 1:100



Optie: Uitbouw achtergevel 120cm

Woningtype: L72

Bouwnummer: _____

Optienummer: 1.A.X.19

Schaal: 1:50 / 1:100

Datum: 18-04-2023

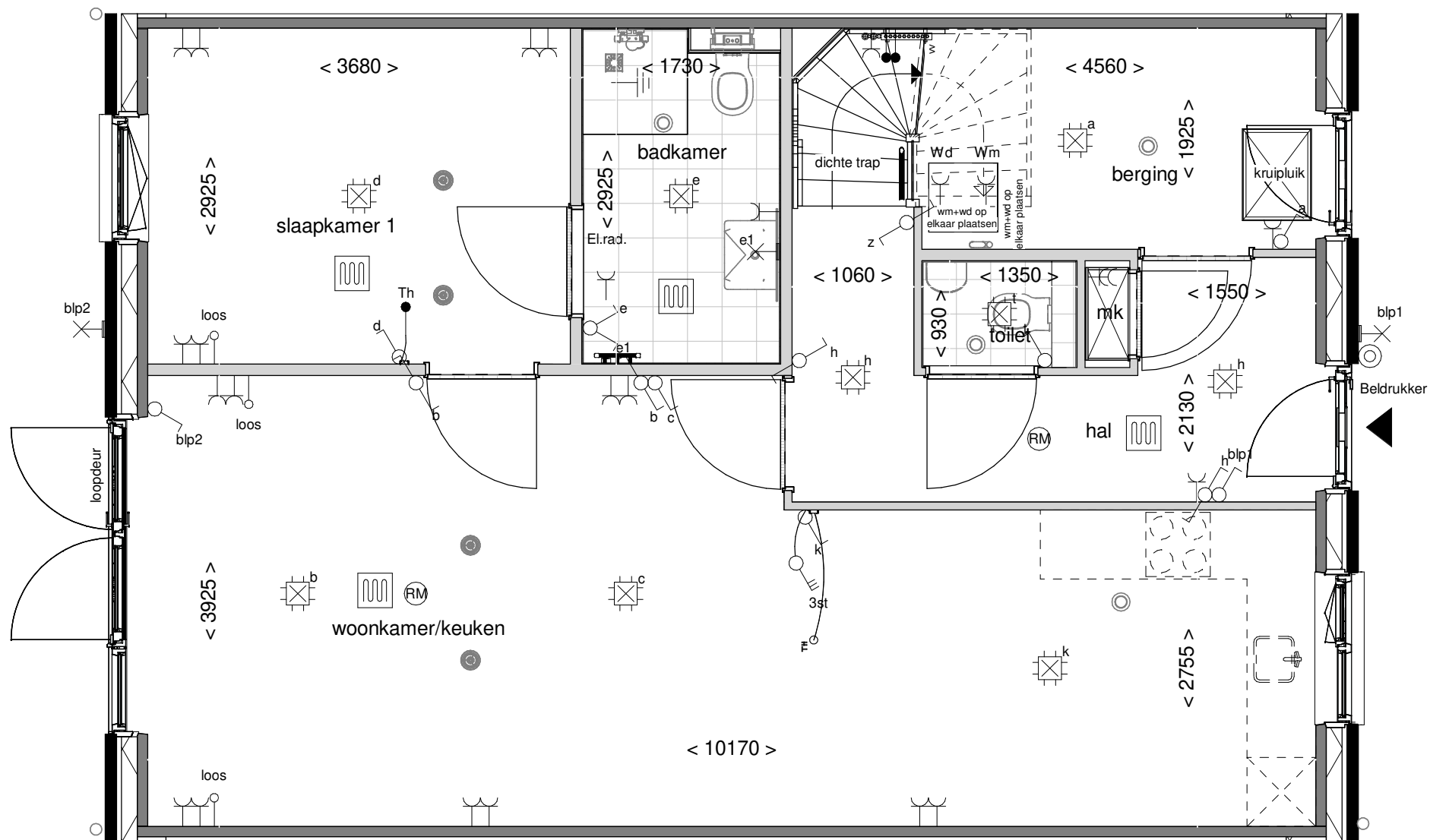

Achtergevel schaal 1:100

**BENT
WIJCK**
BENTHUIZEN

Optie: dubbele deuren
achtergevel

Woningtype: L72

Bouwnummer:

Optienummer: 1.A.X.58

Schaal: 1:50 / 1:100

Datum: 18-04-2023

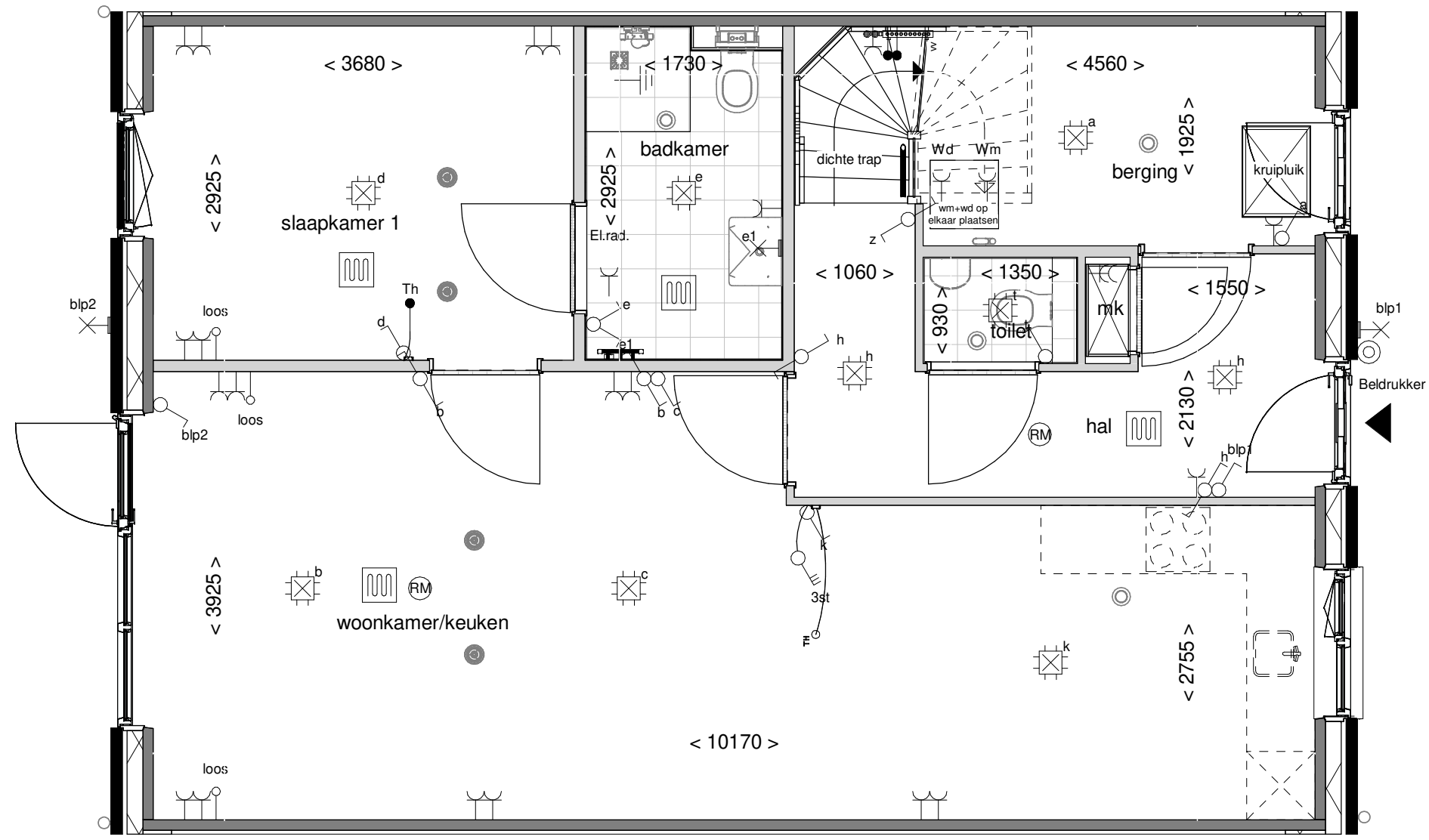

Achtergevel schaal 1:100

**BENT
WIJCK**
BENTHUIZEN

Optie: **Laag kozijn
achtergevel**

Woningtype: **L72**

Bouwnummer:

Optienummer: **1.C.L.76**

Schaal: **1:50 / 1:100**

Datum: **18-04-2023**

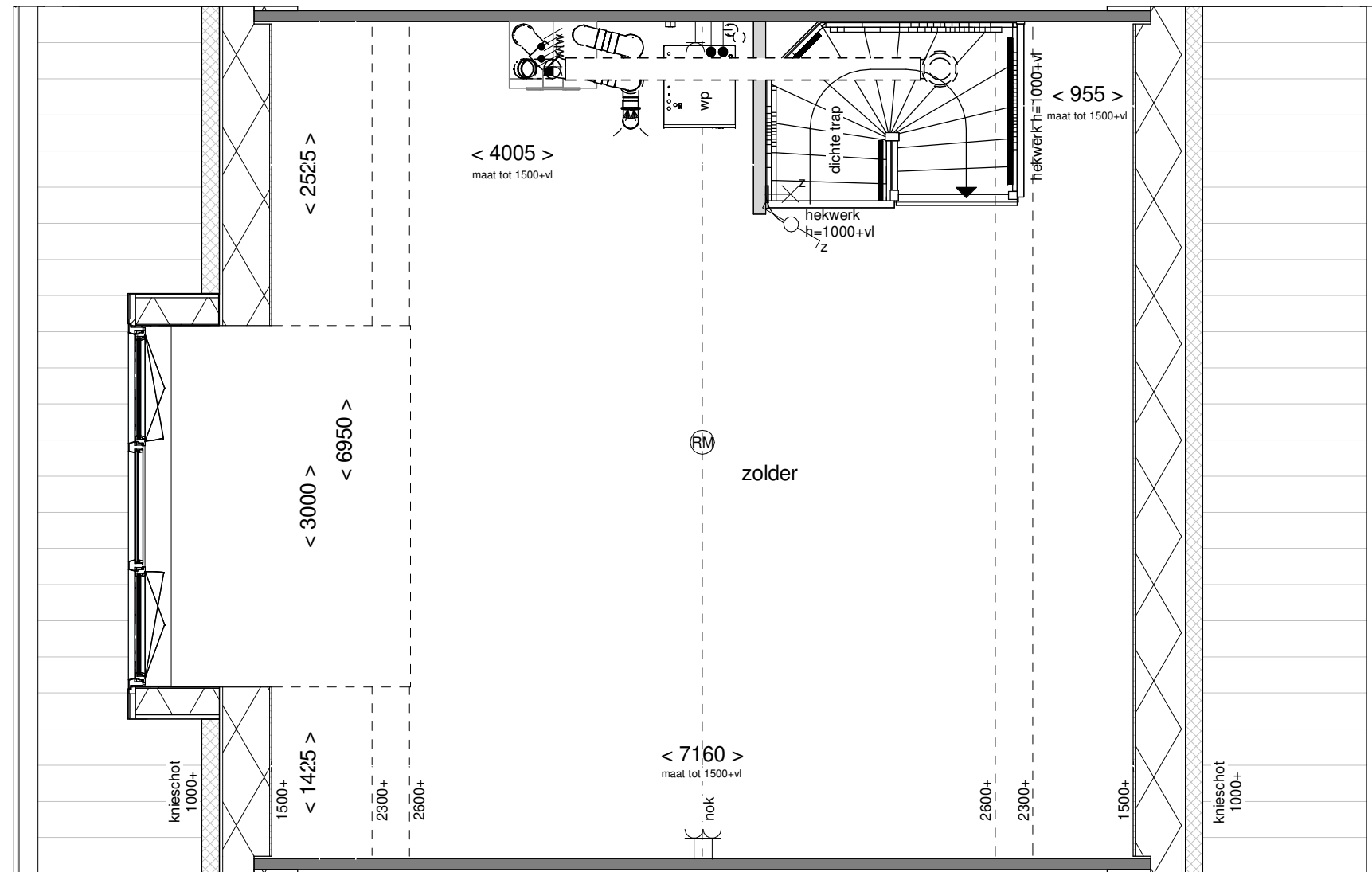

Achtergevel schaal 1:100

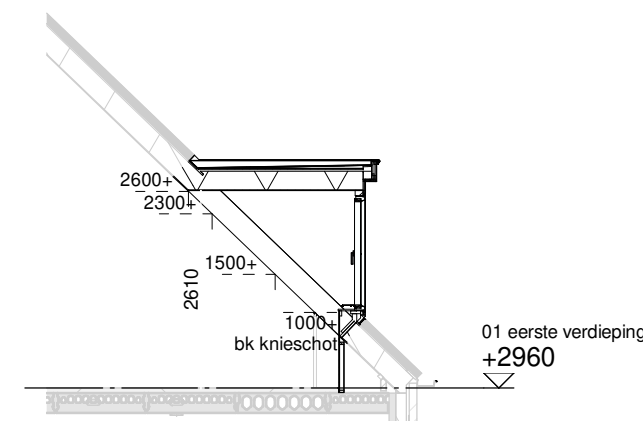

Doorsnede schaal 1:100

**BENT
WIJCK**
BENTHUIZEN

Optie: **Dakkapel
achtergevel**

Woningtype: **L72**

Bouwnummer:

Optienummer: **1.B.X.34A**

Schaal: **1:50 / 1:100**

Datum: **18-04-2023**

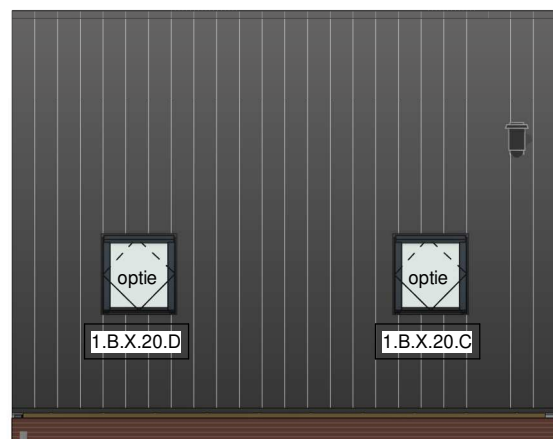
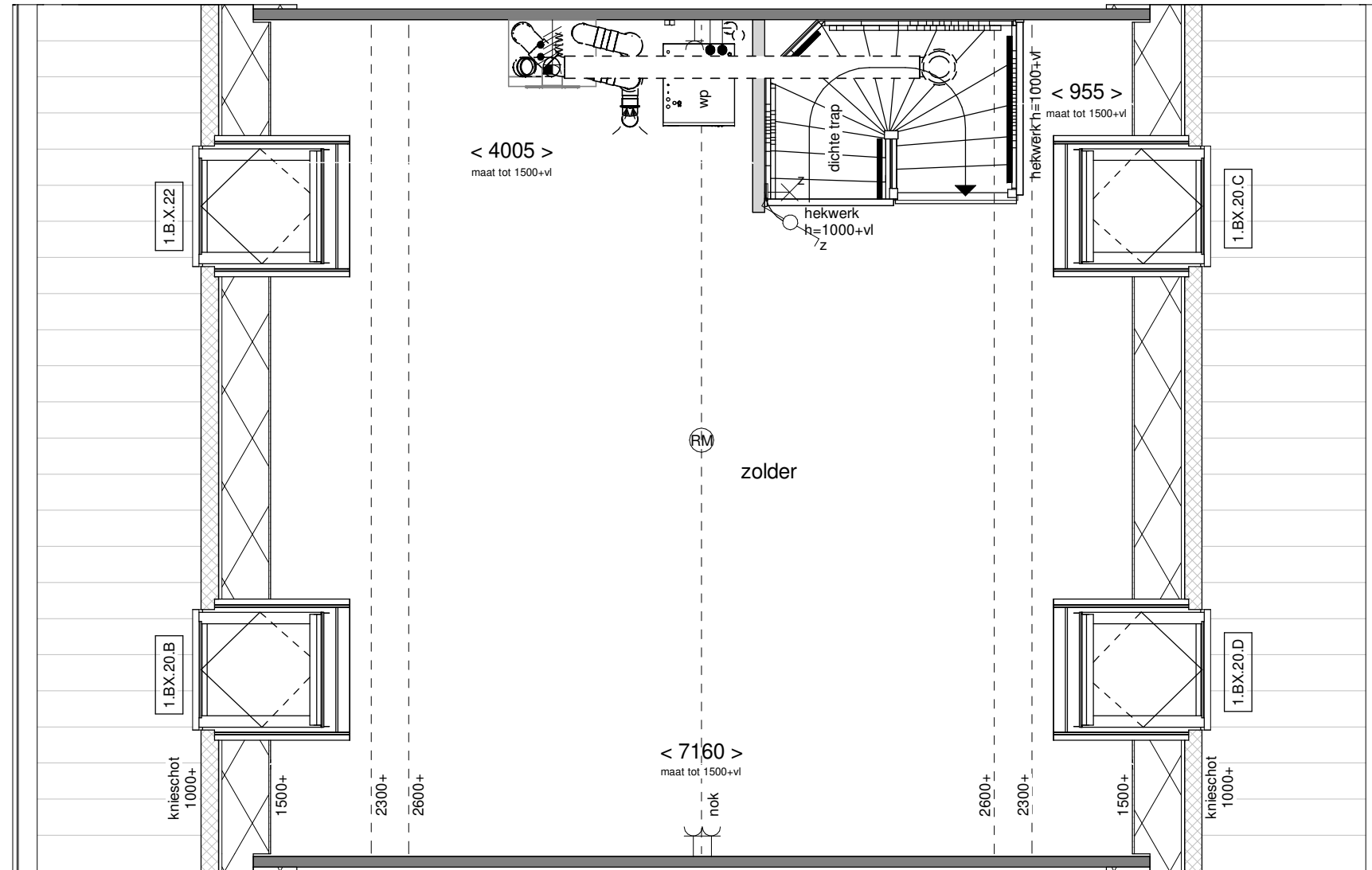

Voorgevel schaal 1:100

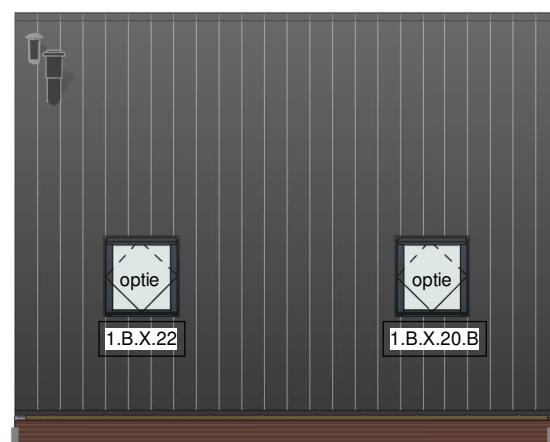

Achtergevel schaal 1:100

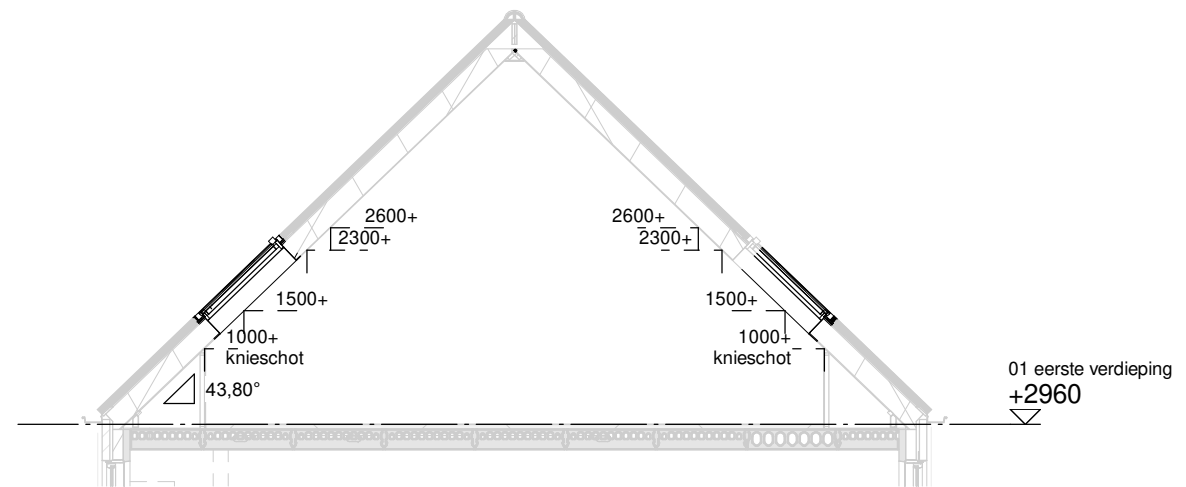

Doorsnede schaal 1:100

Optie: Dakramen voor- en achtergevel

Woningtype: L72

Bouwnummer:

Optienummer: 1.B.X.20 / 1.B.X.22

Schaal: 1:50 / 1:100

Datum: 18-04-2023

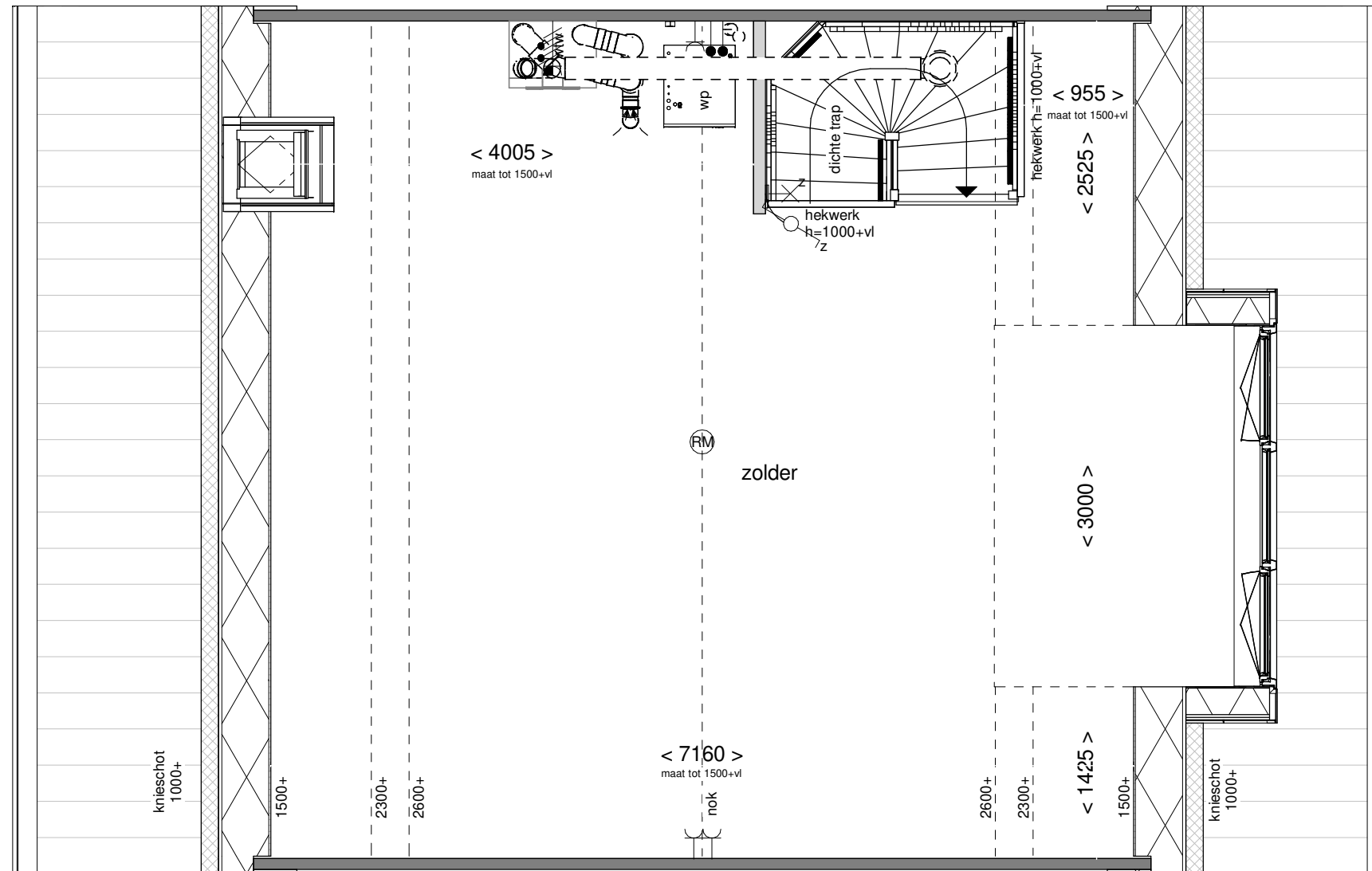

Voorgevel schaal 1:100

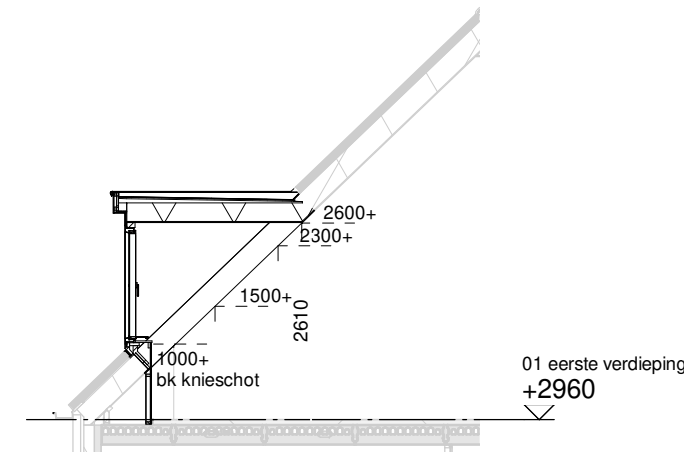

Doorsnede schaal 1:100



Optie: Dakkapel
voorgevel breed

Woningtype: L72

Bouwnummer:

Optienummer: 1.B.X.34V

Schaal: 1:50 / 1:100

Datum: 18-04-2023

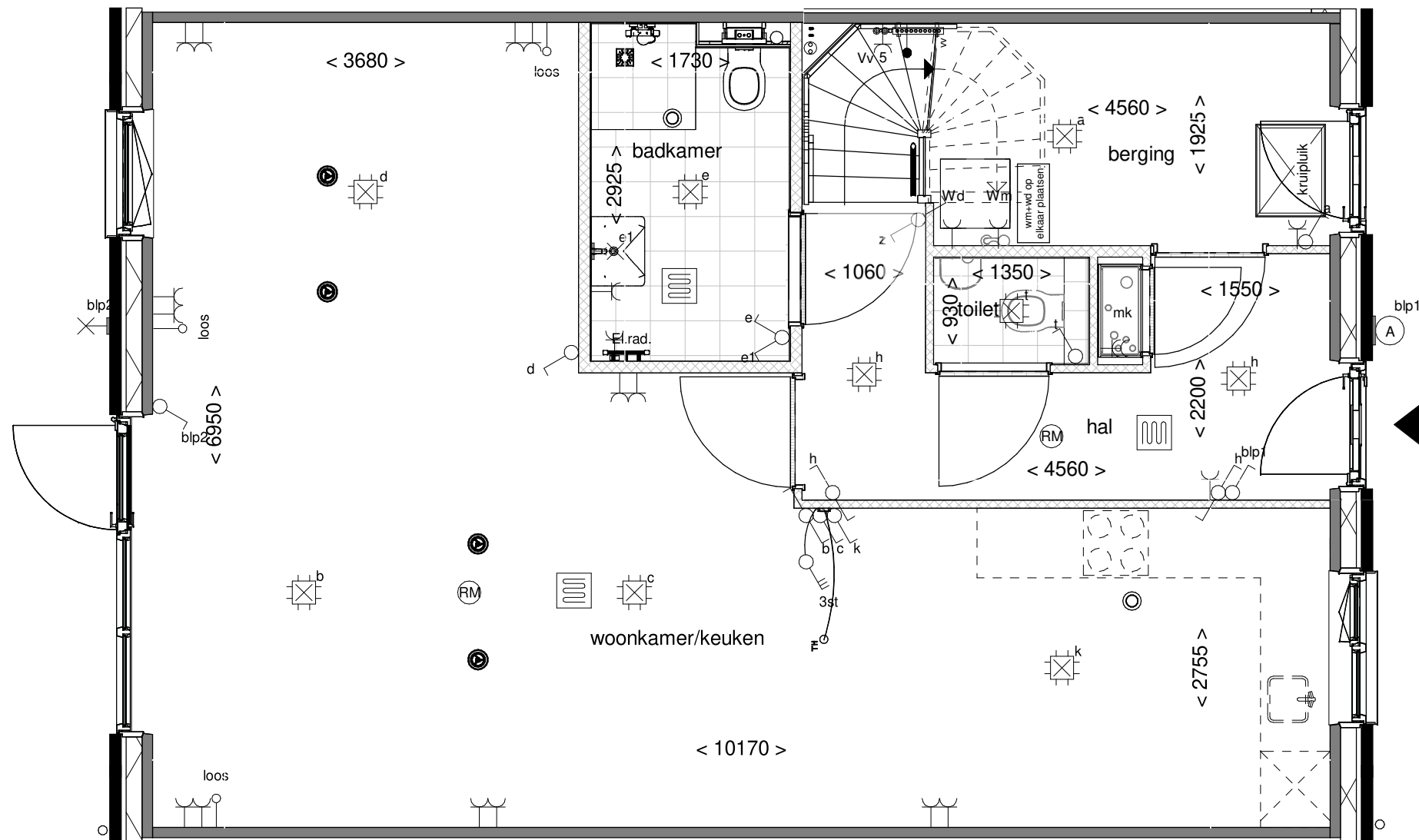

Optie: **Slpk bij woonkamer betrekken variant 1**

Woningtype: **L72**

Bouwnummer: _____

Optienummer: **1.C.L.10**

Schaal: **1:50**

Datum: **18-04-2023**

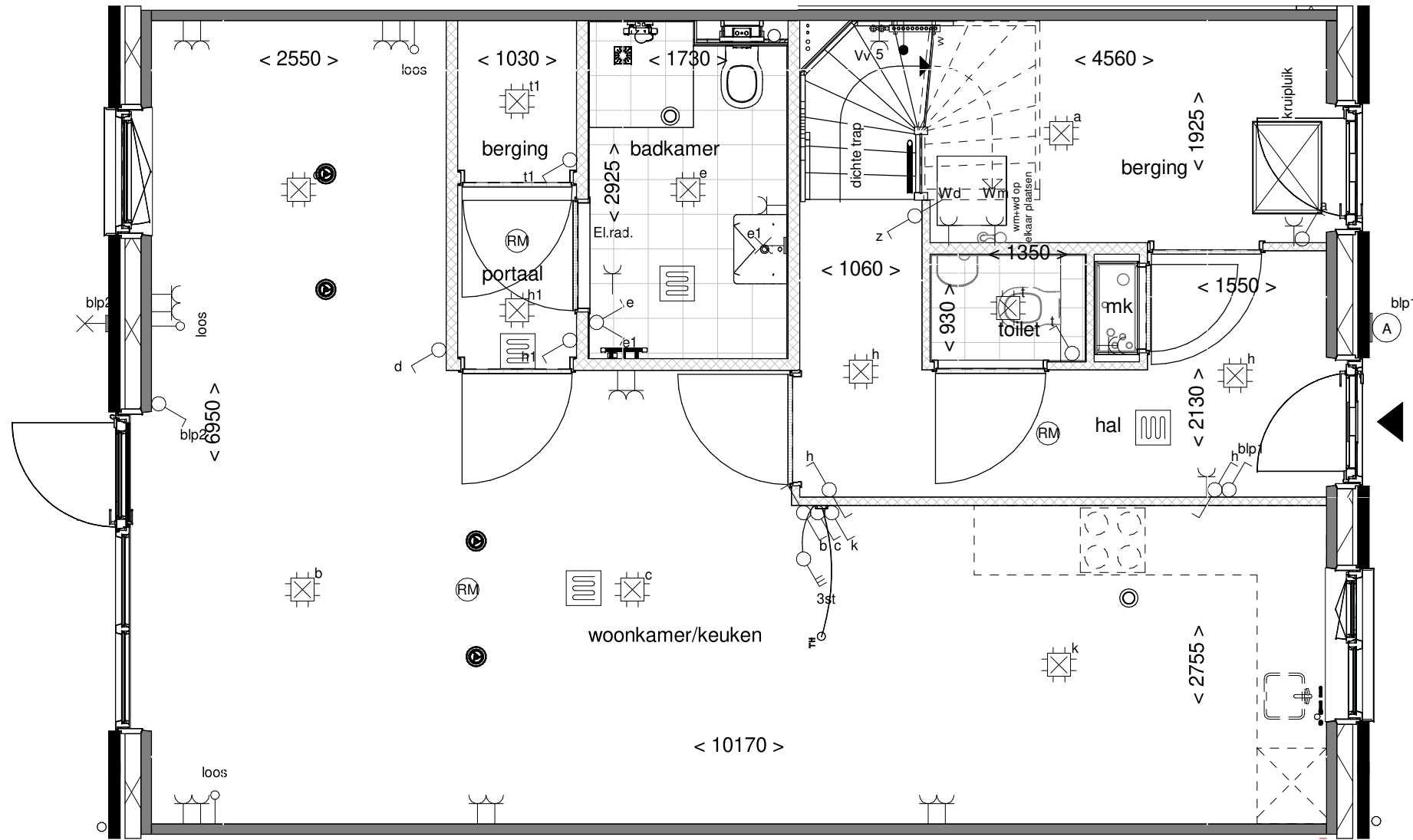

Optie: Slpk bij woonkamer
betrekken variant 2

Woningtype: L72

Bouwnummer:

Optienummer: 1.C.L.12

Schaal: 1:50

Datum: 18-04-2023

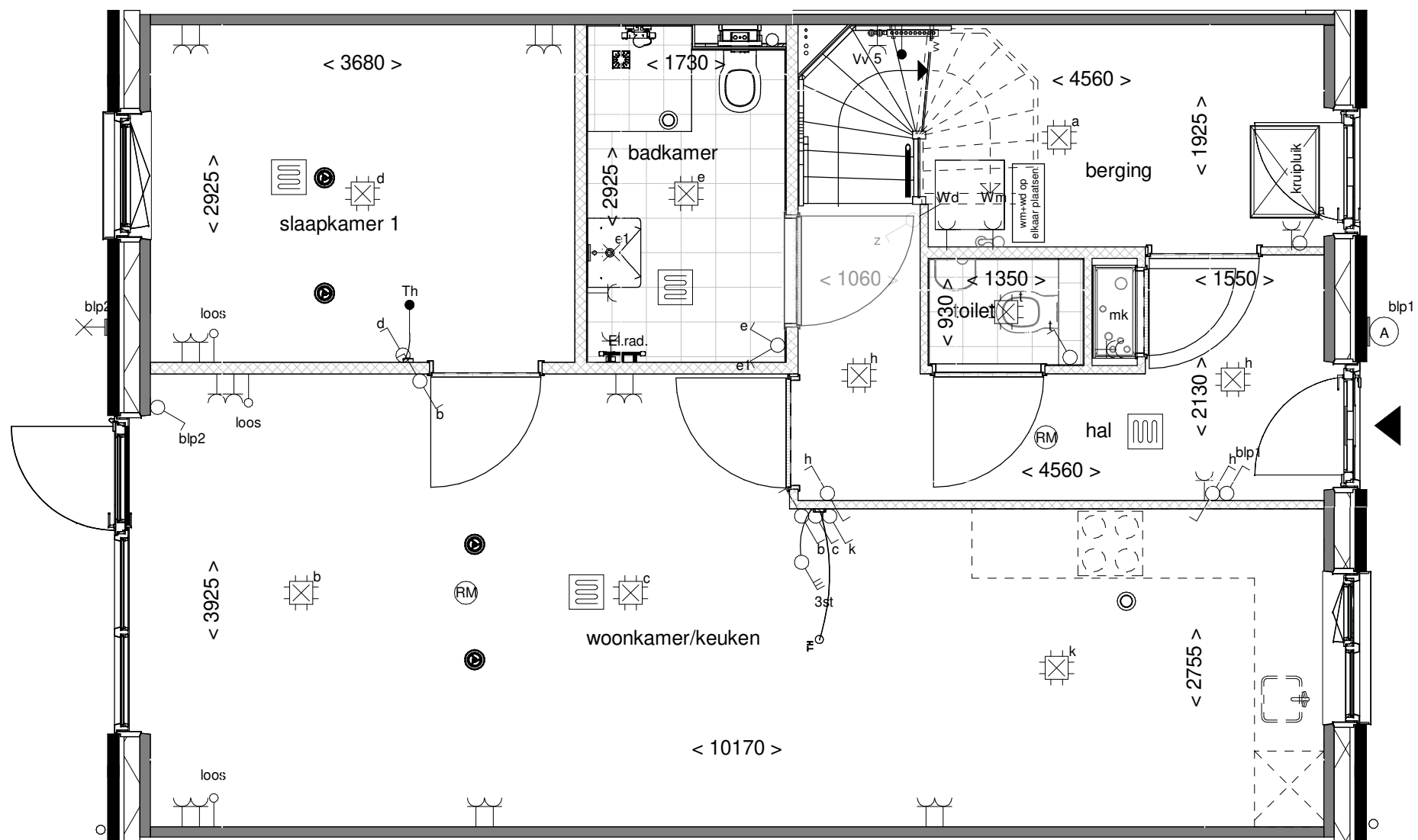

Optie: Badkamerdeur verplaatsen hal

Woningtype: L72

Bouwnummer: _____

Optienummer: 1.C.L.14

Schaal: 1:50

Datum: 18-04-2023

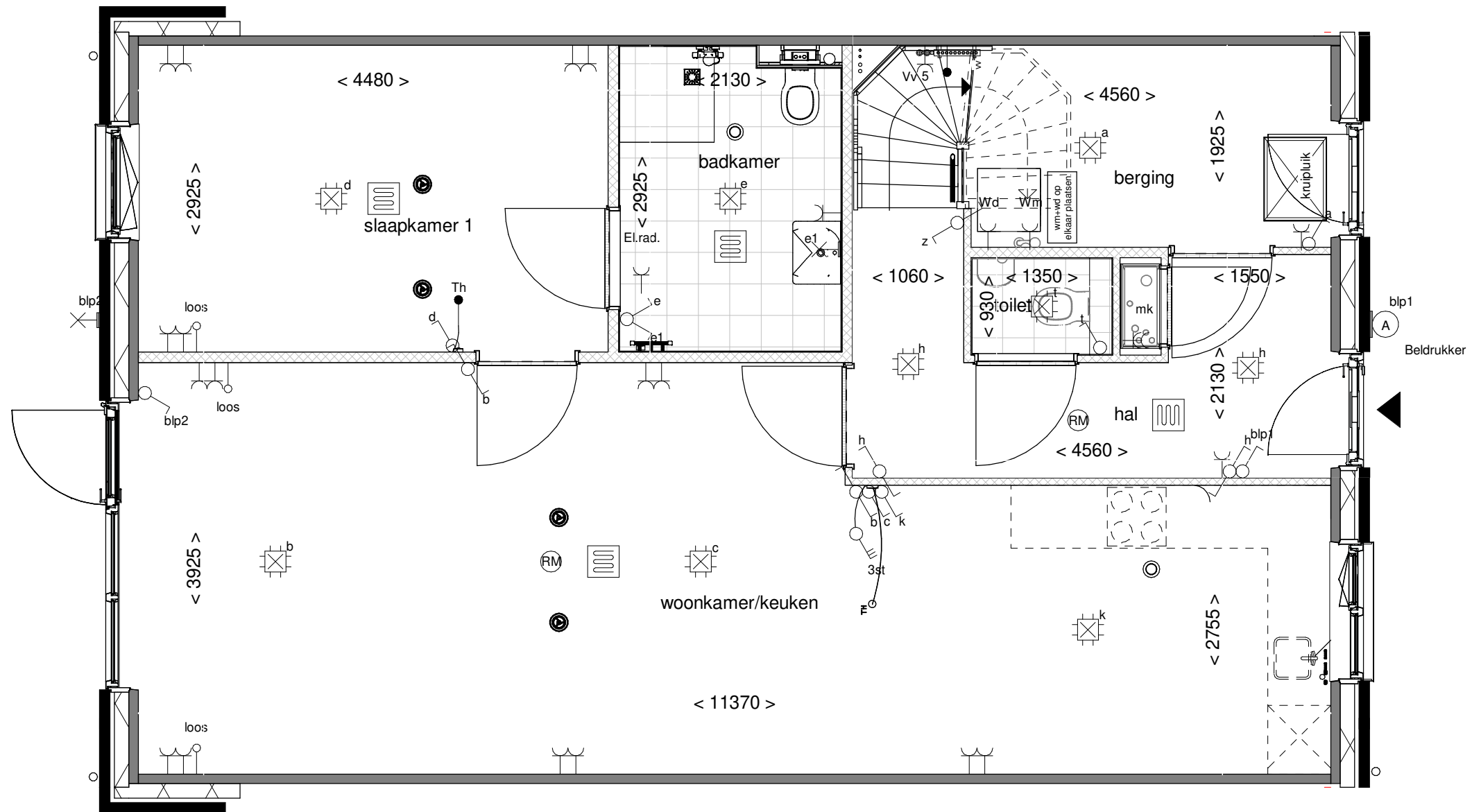

Optie: **Badk. vergroten
i.c.m. 1.A.X.19**

Woningtype: **L72**

Bouwnummer:

Optienummer: **1.C.L.16 + 1.C.L.19**

Schaal: **1:50**

Datum: **18-04-2023**

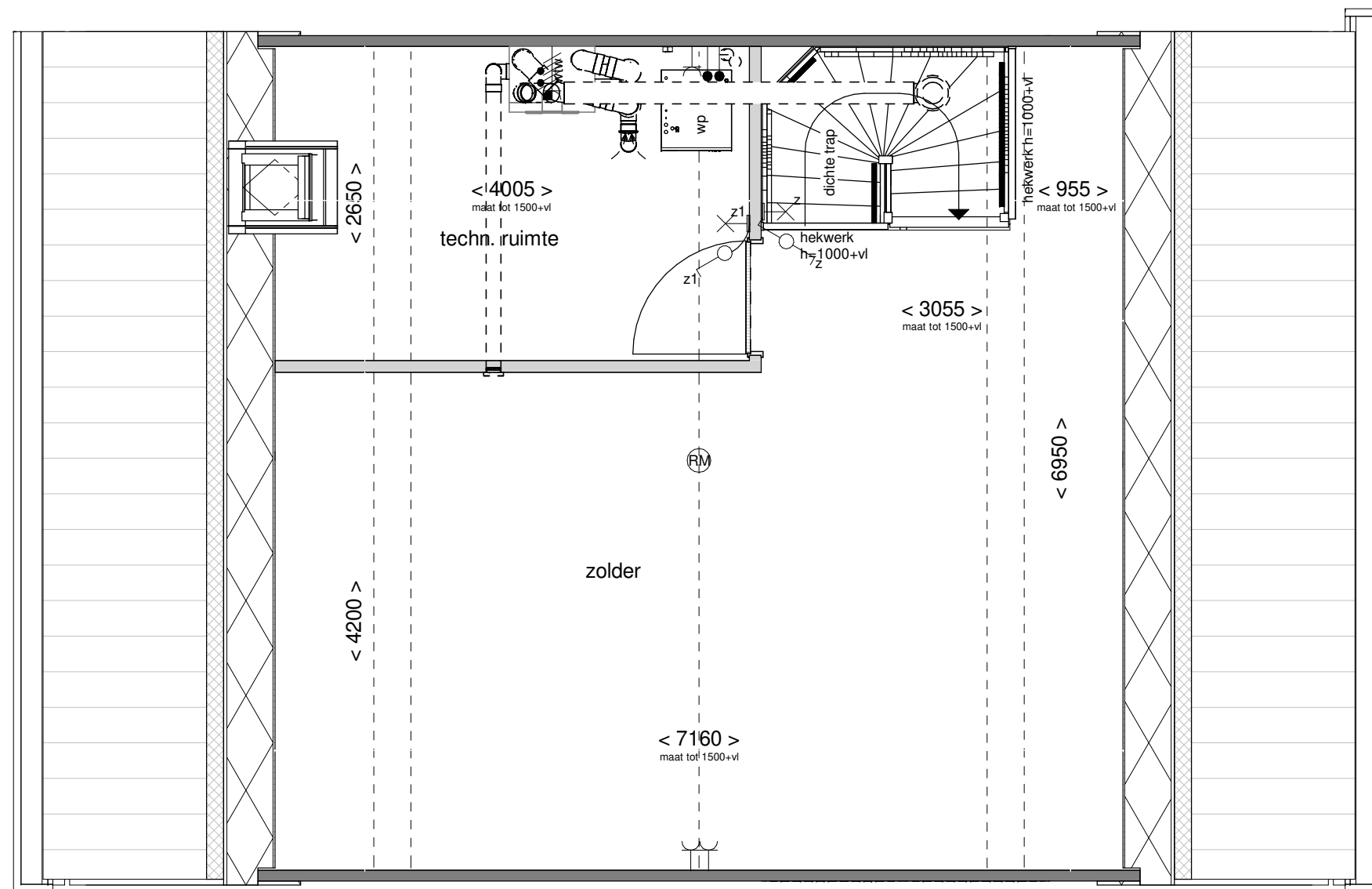

Optie: Indeling met techniekruimte

Woningtype: L72

Bouwnummer: _____

Optienummer: 1.C.L.70

Schaal: 1:50

Datum: 18-04-2023

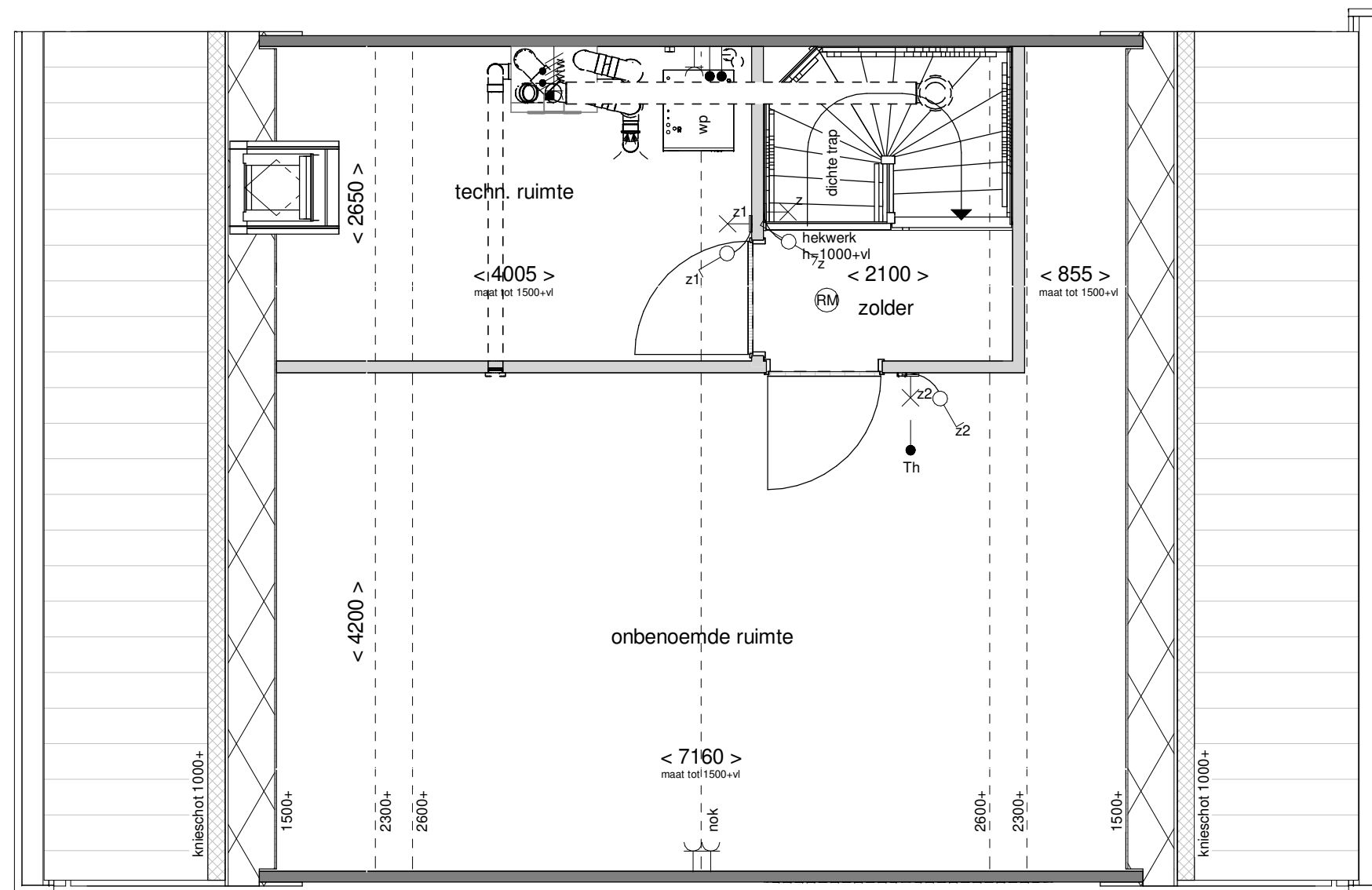

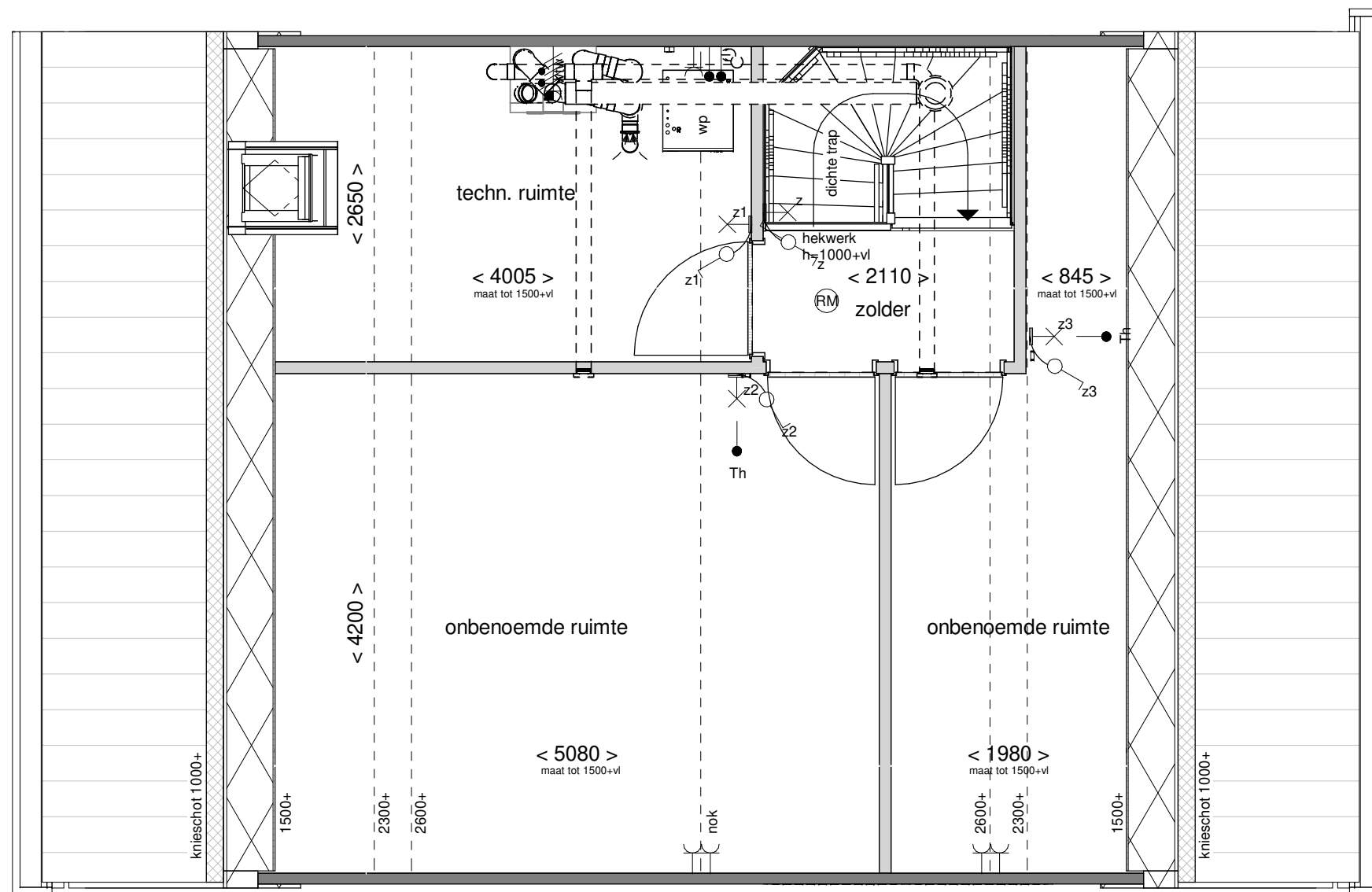

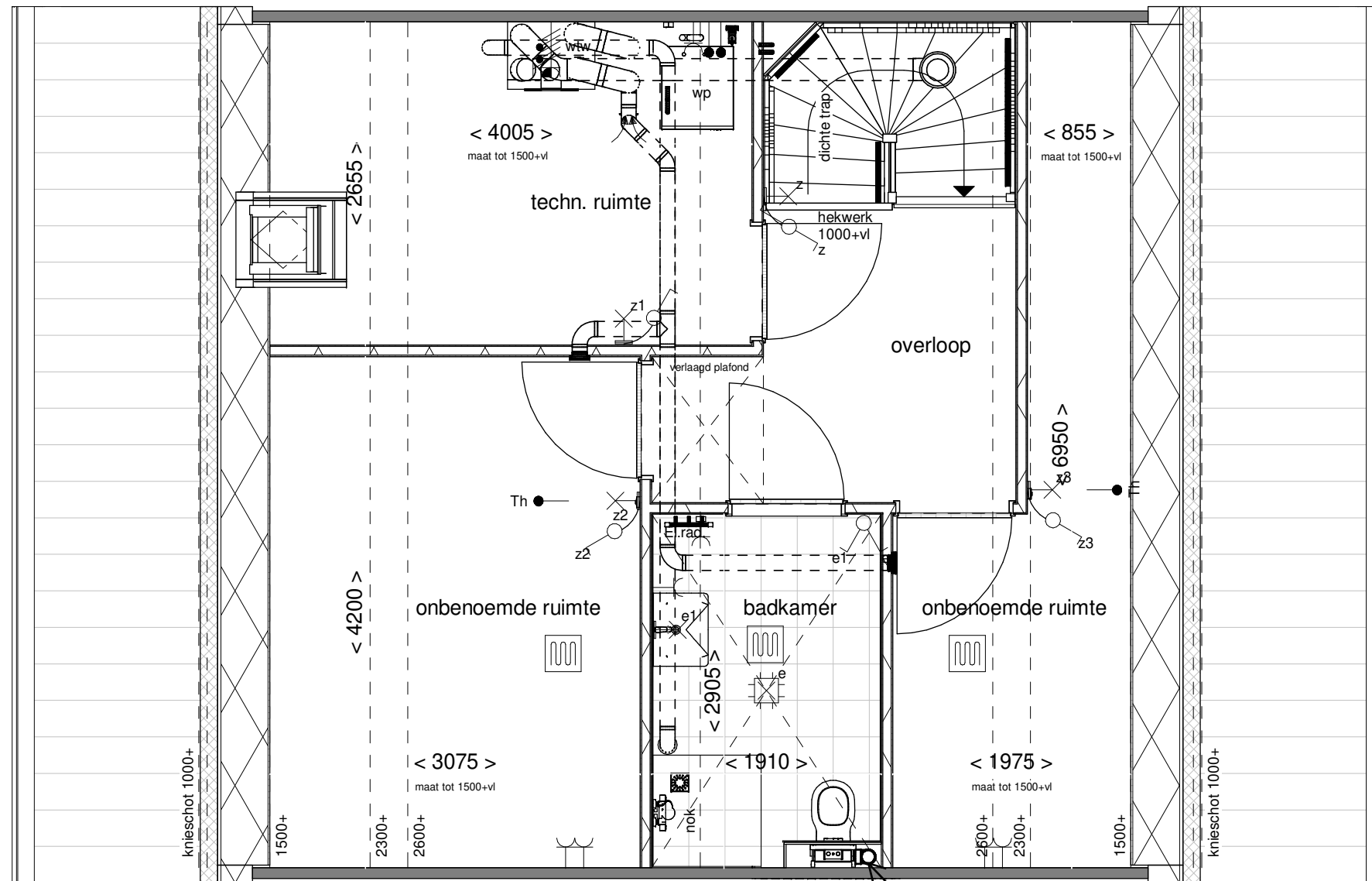

extra leiding koper op de begane grond

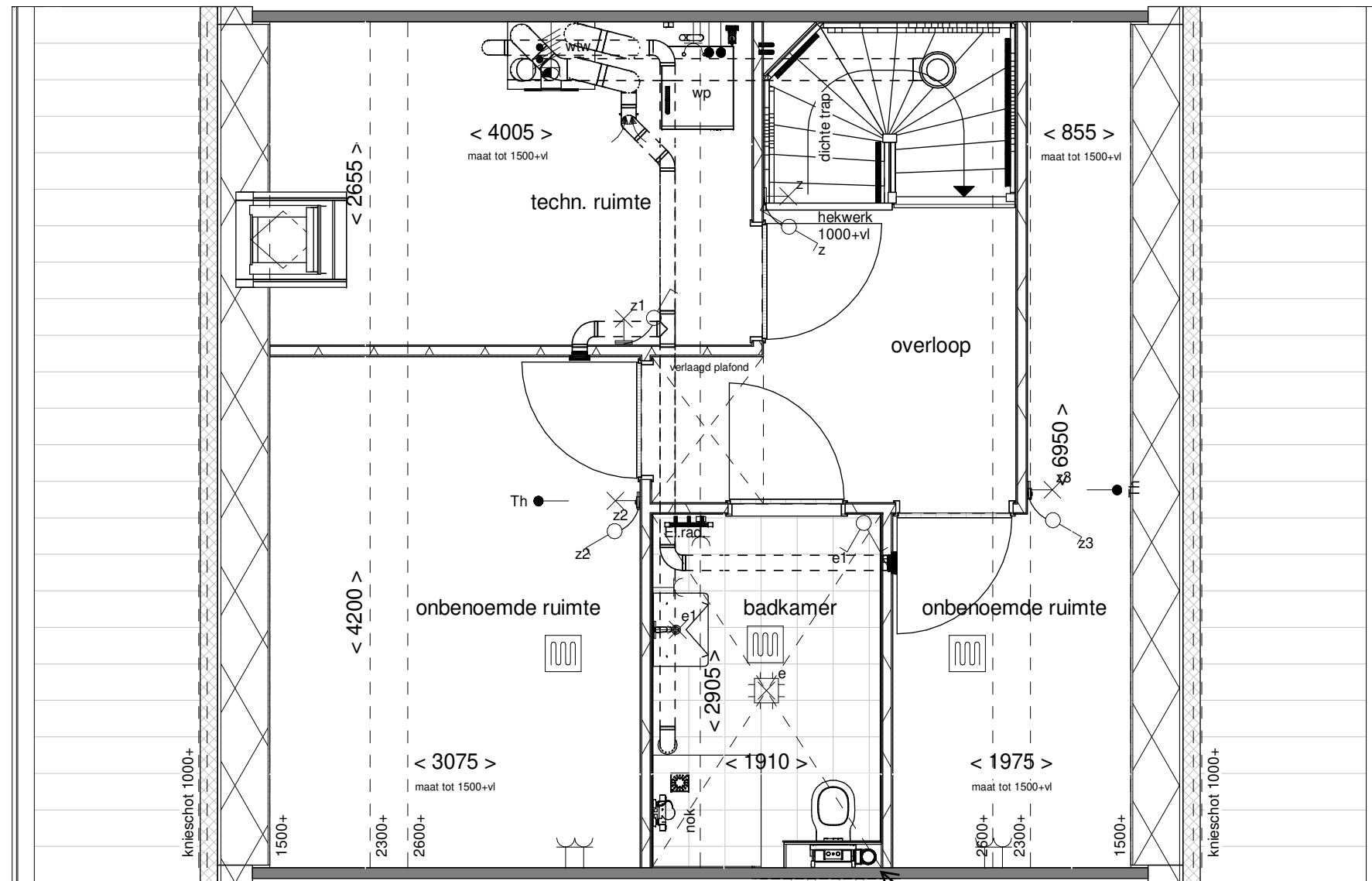

extra leiding koker op de begane grond

Badkamer begane grond komt te vervallen



Optie: Indeling met badkamer
tech.- en 2 onb. ruimtes

Woningtype: L72

Bouwnummer:

Optienummer: 1.C.L.75A

Schaal: 1:50

Datum: 18-04-2023